

# EIKI

MULTIMEDIA PROJECTOR

MODEL **LC-XB26**  
**LC-XB21**

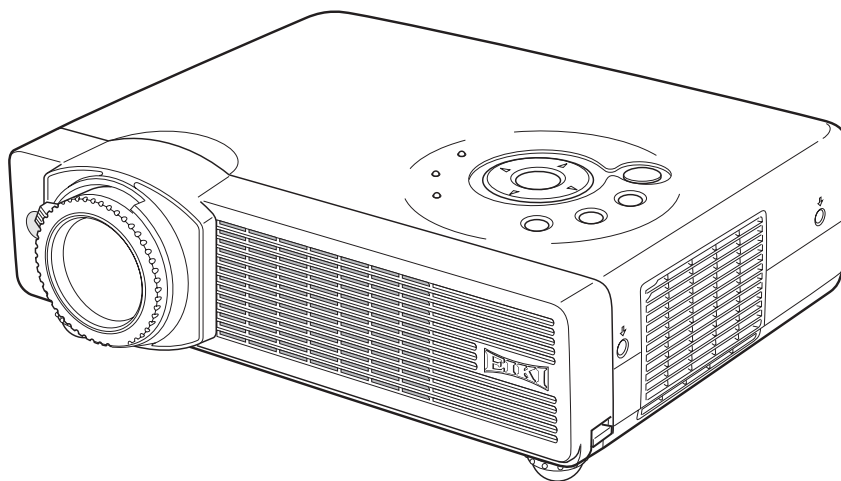

## OWNER'S MANUAL

# Features and Design

---

This Multimedia Projector is designed with the most advanced technology for portability, durability, and ease of use. This projector utilizes built-in multimedia features, a palette of 16.77 million colors, and matrix liquid crystal display (LCD) technology.

## ◆ **Compact Design**

---

This projector is designed compact in size and weight. It is easy to carry and work anywhere you wish to use.

## ◆ **Compatibility**

---

The projector widely accepts various video and computer input signals including; Computers, 6 Color systems, Component video, S-video and RGB scart.

## ◆ **Simple Computer System Setting**

---

The projector has the Multi-scan system to conform to almost all computer output signals quickly. (See page 24, 28, and 42.)

## ◆ **Digital Zoom (for Computer)**

---

The digital zoom function expands (to approx. 16 times of screen size) or compress the image size, allowing you to focus on crucial information at a presentation. (See page 34.)

## ◆ **Power Management**

---

The Power management function reduces power consumption and maintain the lamp life. (See page 45.)

## ◆ **User's Logo**

---

A projected image can be captured and used for the starting display of the projector with the Capture function. You can also display the captured image in an interval during your presentation instead of blackout image with the No show function. (See page 25 and 44.)

## ◆ **Selectable Lamp Mode**

---

Brightness of the projection lamp can be selected in the Setting menu. (See page 45.)

## ◆ **Blackboard Function**

---

Blackboard\* can be used as a projection screen.

\* The board color is limited to Green.

(See page 32 and 38.)

## ◆ **Film Function**

---

The Film function reproduces pictures faithful to the original film quality from 3:2 pull-down video contents.

(See page 40.)

## ◆ **PIN Code Lock Function**

---

The PIN code lock function prevents others except users from using the projector. (See page 20 and 47.)

## ◆ **Multilanguage Menu Display**

---

Operation menu is available in 12 languages; English, German, French, Italian, Spanish, Portuguese, Dutch, Swedish, Russian, Chinese, Korean, or Japanese. (See page 42.)

## ◆ **Switchable Interface Terminal**

---

The projector provides a switchable interface terminal. You can use the terminal as computer input or monitor output conveniently. (See page 44.)

## ◆ **Auto Setup Function**

---

For quick and easy setup of the projector, Auto Setup function is provided. Vertical auto keystone correction and Auto PC adjustment is performed with just pressing one button. (See page 24 and 42.)

# Table of Contents

<b>Features and Design</b> .....	<b>2</b>	<b>Computer Input</b> .....	<b>27</b>
<b>Table of Contents</b> .....	<b>3</b>	Input Source Selection	27
<b>To the Owner</b> .....	<b>4</b>	Computer System Selection	28
<b>Safety Instructions</b> .....	<b>5</b>	Auto PC Adjustment	29
Air Circulation	6	Manual PC Adjustment	30
Installing the Projector in Proper Position	6	Image Level Selection	32
Moving the Projector	6	Image Level Adjustment	33
<b>Compliance</b> .....	<b>7</b>	Screen Size Adjustment	34
<b>Part Names and Functions</b> .....	<b>8</b>	<b>Video Input</b> .....	<b>35</b>
Front	8	Input Source Selection (Video, S-Video)	35
Back	8	Input Source Selection (Component, RGB Scart 21-Pin)	36
Bottom	8	Video System Selection	37
Rear Terminal	9	Image Level Selection	38
Top Control	10	Image Level Adjustment	39
Remote Control	11	Screen Size Adjustment	41
Laser Pointer Function	12	<b>Setting</b> .....	<b>42</b>
Pointer Function	12	Setting	42
Wireless Mouse Operation	13	<b>Maintenance and Cleaning</b> .....	<b>49</b>
Operating Range	13	Warning Indicator	49
Remote Control Code	14	Cleaning the Air Filters	50
Remote Control Battery Installation	14	Attaching the Lens Cover	50
<b>Installation</b> .....	<b>15</b>	Cleaning the Projection Lens	51
Positioning the Projector	15	Cleaning the Projector Cabinet	51
Adjustable Feet	15	Lamp Replacement	52
Connecting the AC Power Cord	16	Lamp Replace Counter	53
Connecting to a Computer	17	<b>Appendix</b> .....	<b>54</b>
Connecting to Video Equipment	18	Troubleshooting	54
Connecting to Component Video Equipment	19	Menu Tree	56
<b>Basic Operation</b> .....	<b>20</b>	Indicators and Projector Condition	58
Turning On the Projector	20	Compatible Computer Specifications	59
Turning Off the Projector	21	Technical Specifications	60
How to Operate the On-Screen Menu	22	Optional Parts	61
Menu Bar	23	Configurations of Terminals	62
Zoom and Focus Adjustment	24	PIN Code Number Memo	63
Auto Setup Function	24		
Keystone Adjustment	25		
Picture Freeze Function	25		
No Show Function	25		
P-Timer Function	26		
Sound Adjustment	26		

---

## Trademarks

Each name of corporations or products in this book is either a registered trademark or a trademark of its respective corporation.





# To the Owner

Before operating this projector, read this manual thoroughly and operate the projector properly.

This projector provides many convenient features and functions. Operating the projector properly enables you to manage those features and maintains it in better condition for a considerable time.

Improper operation may result in not only shortening the product-life, but also malfunctions, fire hazard, or other accidents.

If your projector seems to operate improperly, read this manual again, check operations and cable connections and try the solutions in the "Troubleshooting" section in the end of this booklet. If the problem still persists, contact the dealer where you purchased the projector or the service center.

	<b>CAUTION</b> <b>RISK OF ELECTRIC SHOCK</b> <b>DO NOT OPEN</b>	
<b>CAUTION :</b> TO REDUCE THE RISK OF ELECTRIC SHOCK, DO NOT REMOVE COVER (OR BACK). NO USER-SERVICEABLE PARTS INSIDE EXCEPT LAMP REPLACEMENT. REFER SERVICING TO QUALIFIED SERVICE PERSONNEL.		
	THIS SYMBOL INDICATES THAT DANGEROUS VOLTAGE CONSTITUTING A RISK OF ELECTRIC SHOCK IS PRESENT WITHIN THIS UNIT.	
	THIS SYMBOL INDICATES THAT THERE ARE IMPORTANT OPERATING AND MAINTENANCE INSTRUCTIONS IN THE OWNER'S MANUAL WITH THIS UNIT.	

## Safety Precaution

**WARNING :** TO REDUCE THE RISK OF FIRE OR ELECTRIC SHOCK, DO NOT EXPOSE THIS APPLIANCE TO RAIN OR MOISTURE.

- This projector produces intense light from the projection lens. Do not stare directly into the lens as possible. Eye damage could result. Be especially careful that children do not stare directly into the beam.
- Install the projector in a proper position. If not, it may result in a fire hazard.
- Provide appropriate space on the top, sides and rear of the projector cabinet for allowing air circulation and cooling the projector. Minimum clearance must be maintained. If the projector is to be built into a compartment or similarly enclosed, the minimum distances must be maintained. Do not cover the ventilation slot on the projector. Heat build-up can reduce the service life of your projector, and can also be dangerous.

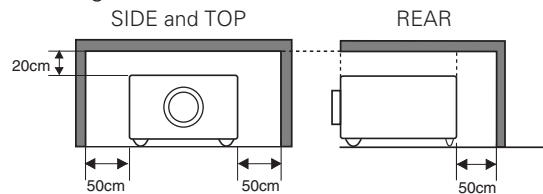

- Do not put any flammable object or spray can near the projector, hot air is exhausted from the ventilation holes.
- If the projector is not to be used for an extended time, unplug the projector from the power outlet.

**READ AND KEEP THIS OWNER'S MANUAL FOR LATER USE.**

## CAUTION

Not for use in a computer room as defined in the Standard for the Protection of Electronic Computer/Data Processing Equipment, ANSI/NFPA 75.

Ne puet être utilisé dans une salle d'ordinateurs telle que définie dans la norme ANSI/NFPA 75 Standard for Protection of Electronic Computer/Data Processing Equipment

# Safety Instructions

All the safety and operating instructions should be read before the product is operated.

Read all of the instructions given here and retain them for later use. Unplug this projector from AC power supply before cleaning. Do not use liquid or aerosol cleaners. Use a damp cloth for cleaning.

Follow all warnings and instructions marked on the projector.

For added protection to the projector during a lightning storm, or when it is left unattended and unused for long periods of time, unplug it from the wall outlet. This will prevent damage due to lightning and power line surges.

---

Do not expose this unit to rain or use near water... for example, in a wet basement, near a swimming pool, etc...

Do not use attachments not recommended by the manufacturer as they may cause hazards.

Do not place this projector on an unstable cart, stand, or table. The projector may fall, causing serious injury to a child or adult, and serious damage to the projector. Use only with a cart or stand recommended by the manufacturer, or sold with the projector. Wall or shelf mounting should follow the manufacturer's instructions, and should use a mounting kit approved by the manufacturers.

An appliance and cart combination should be moved with care. Quick stops, excessive force, and uneven surfaces may cause the appliance and cart combination to overturn.



---

Slots and openings in the back and bottom of the cabinet are provided for ventilation, to ensure reliable operation of the equipment and to protect it from overheating.

The openings should never be covered with cloth or other materials, and the bottom opening should not be blocked by placing the projector on a bed, sofa, rug, or other similar surface. This projector should never be placed near or over a radiator or heat register.

This projector should not be placed in a built-in installation such as a book case unless proper ventilation is provided.

Never push objects of any kind into this projector through cabinet slots as they may touch dangerous voltage points or short out parts that could result in a fire or electric shock. Never spill liquid of any kind on the projector.

Do not install the projector near the ventilation duct of air-conditioning equipment.

This projector should be operated only from the type of power source indicated on the marking label. If you are not sure of the type of power supplied, consult your authorized dealer or local power company.

Do not overload wall outlets and extension cords as this can result in fire or electric shock. Do not allow anything to rest on the power cord. Do not locate this projector where the cord may be damaged by persons walking on it.

Do not attempt to service this projector yourself as opening or removing covers may expose you to dangerous voltage or other hazards. Refer all servicing to qualified service personnel.

Unplug this projector from wall outlet and refer servicing to qualified service personnel under the following conditions:

- a. When the power cord or plug is damaged or frayed.
- b. If liquid has been spilled into the projector.
- c. If the projector has been exposed to rain or water.
- d. If the projector does not operate normally by following the operating instructions. Adjust only those controls that are covered by the operating instructions as improper adjustment of other controls may result in damage and will often require extensive work by a qualified technician to restore the projector to normal operation.
- e. If the projector has been dropped or the cabinet has been damaged.
- f. When the projector exhibits a distinct change in performance-this indicates a need for service.

When replacement parts are required, be sure the service technician has used replacement parts specified by the manufacturer that have the same characteristics as the original part. Unauthorized substitutions may result in fire, electric shock, or injury to persons.

Upon completion of any service or repairs to this projector, ask the service technician to perform routine safety checks to determine that the projector is in safe operating condition.

---



**Voor de klanten in Nederland**

Bij dit product zijn batterijen geleverd. Wanneer deze leeg zijn, moet u ze niet weggoien maar inleveren als KCA.



## **Air Circulation**

Openings in the cabinet are provided for ventilation and to ensure reliable operation of the product and to protect it from overheating, and these openings must not be blocked or covered.

### **CAUTION**

Hot air is exhausted from the exhaust vent. When using or installing the projector, the following precautions should be taken.

- Do not put any flammable objects near the vent.
- Keep the exhaust vent at least 3'(1m) away from any objects.
- Do not touch a peripheral part of the exhaust vent, especially screws and metallic part. This area will become hot while the projector is being used.
- Do not put anything on the cabinet. The materials put on the cabinet will not only get damaged but also cause fire hazard by heat.

Cooling fans are provided to cool down the projector. This projector monitors internal temperature and control the running speed of the cooling fans.

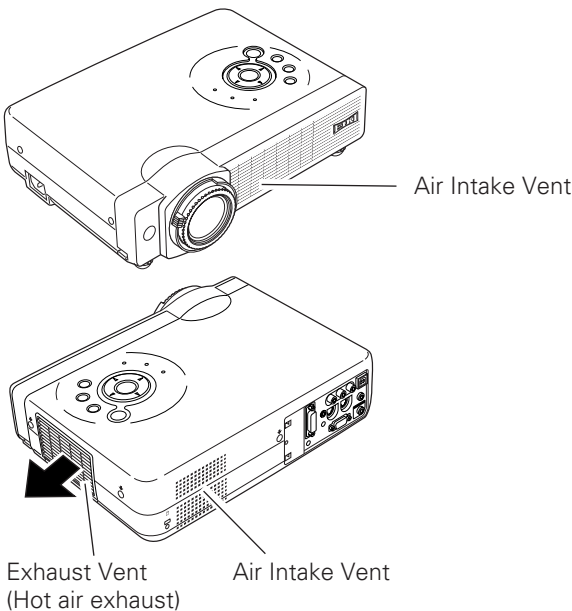

## **Installing the Projector in Proper Position**

Install the projector properly. Improper Installation may reduce the lamp life and cause a fire hazard.

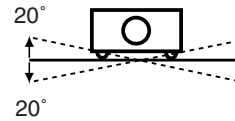

Do not tilt the projector more than 20 degrees above and below.



Do not point the projector up to project an image.



Do not point the projector down to project an image.



Do not put the projector on either side to project an image.

## **Moving the Projector**

When moving the projector, replace the Lens Cover and retract Adjustable Feet to prevent damage to the lens and cabinet.

When the projector is not in use for an extended period, put it into the case (carrying bag) supplied with the projector.

### **CAUTION**

Carrying Bag (supplied) is intended for protection from dust and scratches on the surface of a cabinet, and it is not designed to protect an appliance from external forces. Do not transport a projector through a courier or transport services with this bag, otherwise the projector can be damaged. When handling a projector, do not drop, bump, subject it to strong forces or put other things on the cabinet.

### **USE CAUTION IN CARRYING OR TRANSPORTING THE PROJECTOR**

- Do not drop or bump a projector, otherwise damages or malfunctions may result.
- When carrying a projector, use a suitable carrying case.
- Do not transport a projector by using a courier or transport service in an unsuitable transport case. This may cause damage to a projector. To transport a projector through a courier or transport service, consult your dealer for their information.

## Federal Communication Commission Notice

Note : This equipment has been tested and found to comply with the limits for a Class B digital device, pursuant to part 15 of the FCC Rules. These limits are designed to provide reasonable protection against harmful interference in a residential installation. This equipment generates, uses and can radiate radio frequency energy and, if not installed and used in accordance with the instructions, may cause harmful interference to radio communications. However, there is no guarantee that interference will not occur in a particular installation. If this equipment does cause harmful interference to radio or television reception, which can be determined by turning the equipment off and on, the user is encouraged to try to correct the interference by one or more of the following measures :

- Reorient or relocate the receiving antenna.
- Increase the separation between the equipment and receiver.
- Connect the equipment into an outlet on a circuit different from that to which the receiver is connected.
- Consult the dealer or an experienced radio/TV technician for help.

Use of shielded cable is required to comply with class B limits in Subpart B of Part 15 of FCC Rules.

Do not make any changes or modifications to the equipment unless otherwise specified in the instructions. If such changes or modifications should be made, you could be required to stop operation of the equipment.

Model Number : LC-XB26, LC-XB21  
Trade Name : EIKI  
Responsible party : EIKI International, Inc.  
Address : 30251 Esperanza, Rancho Santa Margarita, CA 92688-2132  
Telephone No. : 800-242-3454 (949-457-0200)

## AC POWER CORD REQUIREMENT

The AC Power Cord supplied with this projector meets the requirement for use in the country you purchased it.

### AC Power Cord for the United States and Canada :

AC Power Cord used in the United States and Canada is listed by the Underwriters Laboratories (UL) and certified by the Canadian Standard Association (CSA).

AC Power Cord has a grounding-type AC line plug. This is a safety feature to be sure that the plug will fit into the power outlet. Do not try to defeat this safety feature. Should you be unable to insert the plug into the outlet, contact your electrician.

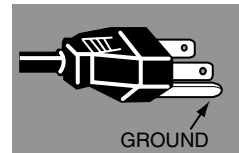

**THE SOCKET-OUTLET SHOULD BE INSTALLED NEAR THE EQUIPMENT AND EASILY ACCESSIBLE.**

# Part Names and Functions

## Front

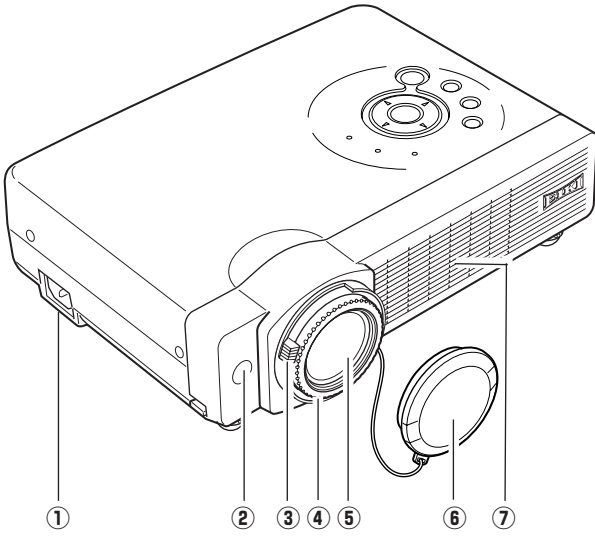

- ① Power Cord Connector
- ② Infrared Remote Receiver
- ③ Zoom Lever
- ④ Focus Ring
- ⑤ Projection Lens
- ⑥ Lens Cover (See page 50 for attaching.)
- ⑦ Air Intake Vent

## Back

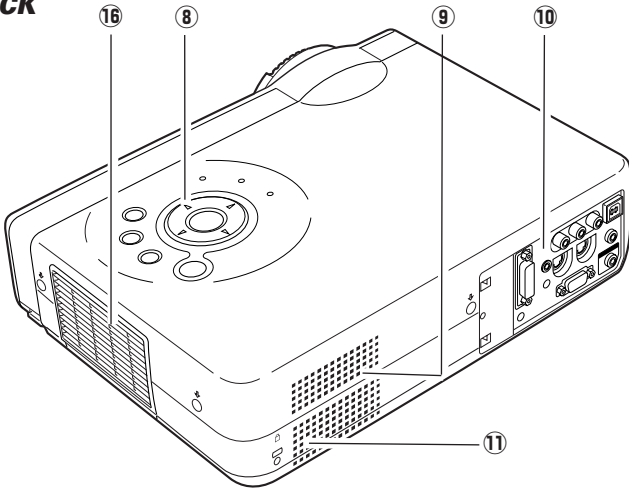

- ⑧ Top Controls and Indicators
- ⑨ Air Intake Vent
- ⑩ Terminals and Connectors
- ⑪ Speaker

- ⑫ Lamp Cover
- ⑬ Air Intake Vent (back and bottom)
- ⑭ Air Filter
- ⑮ Adjustable Feet

- ⑯ Exhaust Vent



Hot air is exhausted from the exhaust vent. Do not put heat-sensitive objects near this side.

## Bottom

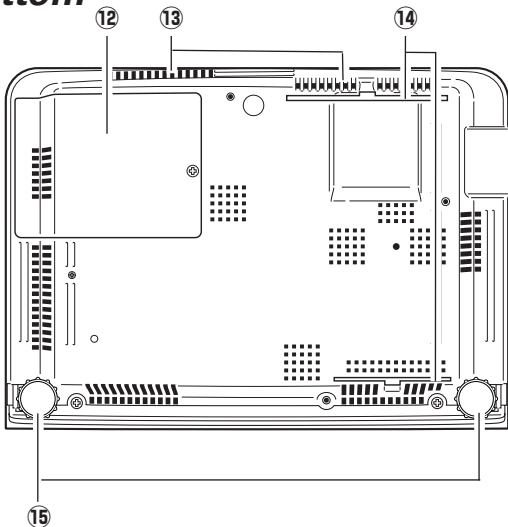

## Rear Terminal

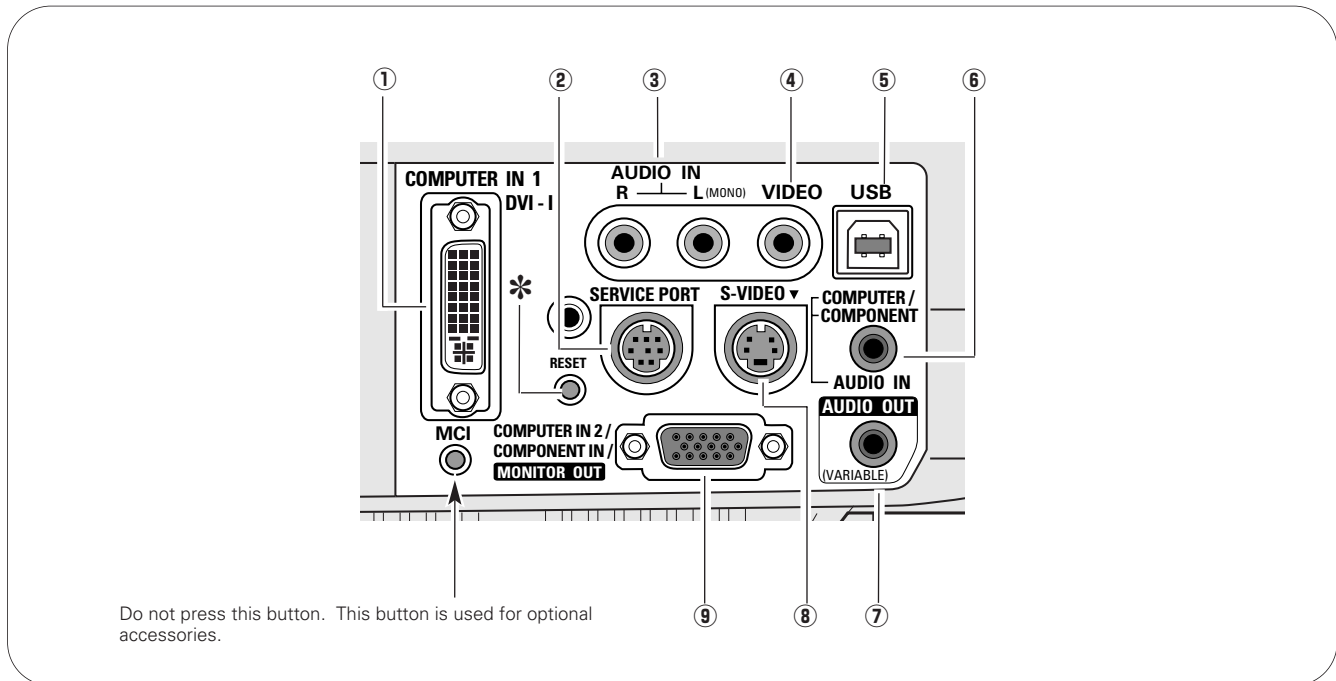

- ① **COMPUTER IN 1 DVI-I**  
Connect output signal from a computer (Digital/Analog DVI-I type) or Multi Card Imager (optional) to this terminal. (p17)
- ② **SERVICE PORT**  
This jack is used to service this projector.
- ③ **AUDIO IN**  
Connect the audio output from video equipment connected to ④ or ⑧ to this jack. (When the audio output is monaural, connect it to L (MONO) jack.) (p18)
- ④ **VIDEO**  
Connect the composite video output from video equipment to VIDEO jack. (p18)
- ⑤ **USB (Series B)**  
When operating the connected computer with the remote control, connect USB port of your computer to this connector with a USB cable. (p17)
- ⑥ **AUDIO IN COMPUTER/ COMPONENT**  
Connect the audio output (stereo) from a computer or video equipment connected to ① or ⑨ to this jack. (p 17, 19)
- ⑦ **AUDIO OUT(VARIABLE)**  
Connect an external audio amplifier to this jack. (p17- 19)  
This terminal outputs sound from AUDIO IN terminal (③ or ⑥).
- ⑧ **S-VIDEO**  
Connect the S-VIDEO output from video equipment to this jack. (p18)
- ⑨ **COMPUTER IN 2/ COMPONENT IN/ MONITOR OUT**  
This terminal is switchable and can be used for input from a computer, video equipment (Component or RGB Scart) or output to the other monitor. Optional cables are required when using this terminal as component input or RGB Scart 21-Pin Video input. (p61)  
Set the terminal up as either Computer input or Monitor output properly. (Used for Monitor out, this terminal outputs only incoming signal from COMPUTER IN 1 DVI-I terminal.) (p17, 19, 44)

\* A built-in micro processor which controls this unit may occasionally malfunction and need to be reset. This can be done by pressing the RESET button with a pen, which will shut down and restart the unit. Do not use the RESET function excessively.

## Top Control

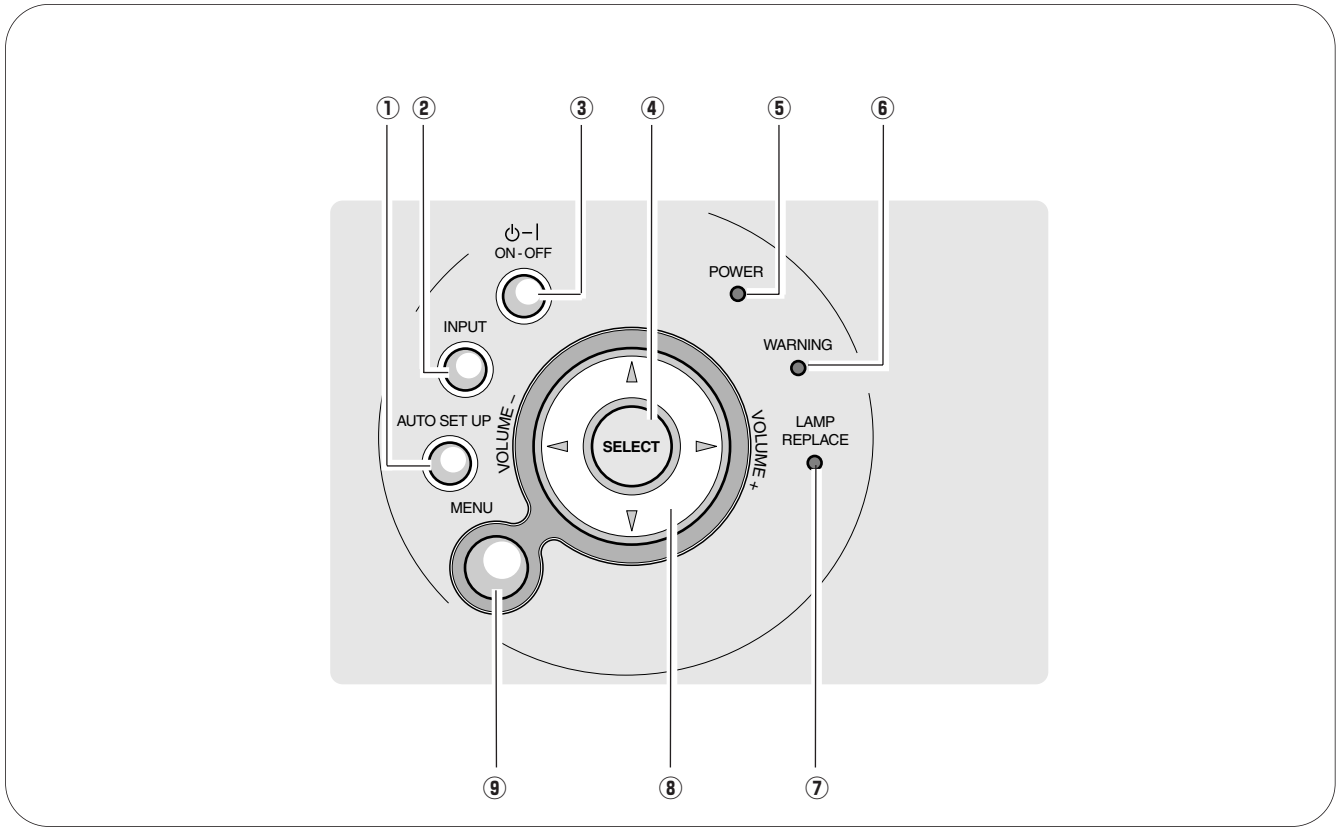

- ① **AUTO SETUP button**  
Corrects vertical keystone distortion and adjusts computer display parameters including Fine sync., Total dots and Picture position. (p24, 42)
- ② **INPUT button**  
Selects input source. (p27, 36)
- ③ **POWER ON-OFF button**  
Turns the projector on or off. (p20, 21)
- ④ **SELECT button**  
Executes the item selected. It is also used to expand/compress the image in Digital zoom +/- mode. (p34)
- ⑤ **POWER indicator**  
Blinks red until the projector gets ready to be turned on. It turns red when the projector is in the stand-by mode. It remains green while the projector is under operation.
- ⑥ **WARNING indicator**  
Lights red when the projector detects abnormal condition. This also blinks red when the internal temperature of the projector exceeds the operating range. (p49)
- ⑦ **LAMP REPLACE indicator**  
Turns yellow when the life of the projection lamp draws to an end. (p52)
- ⑧ **POINT (▲▼◀▶) button**  
Selects an item or adjusts value in the On-Screen Menu. These are also used to pan the image in the Digital zoom +/- mode. (p34)  
Point ◀▶ button are used as VOLUME +/- button. (p26)
- ⑨ **MENU button**  
Opens or closes the On-Screen Menu. (p22)

## Remote Control

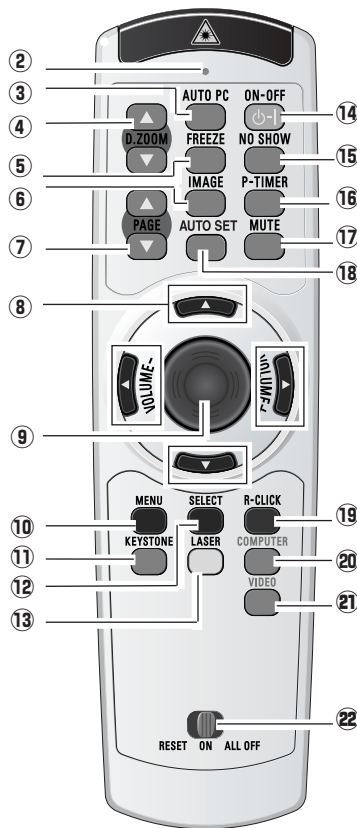
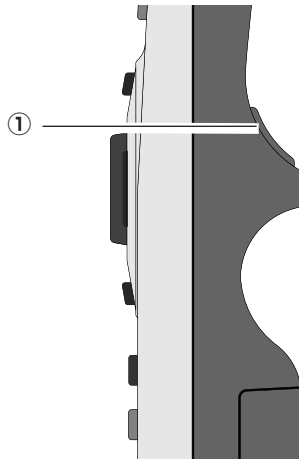

- ① **L-CLICK button**  
Acts as left click for wireless mouse operation. (p13)
- ② **SIGNAL EMISSION indicator**  
This indicator lights red while the laser beam is being emitted from the laser light window or a signal is being sent from the remote control to the projector.
- ③ **AUTO PC button**  
Operates the Auto PC adjustment function. (p29)
- ④ **D.ZOOM button**  
Selects the Digital zoom +/- mode and resize the image. (p34)
- ⑤ **FREEZE button**  
Freezes the projected picture. (p25)
- ⑥ **IMAGE button**  
Selects image levels.(p32, 38)
- ⑦ **PAGE UP/DOWN button**  
Turns pages; the Up button to the previous page and the Down button to the next page for an image from a computer. Connect the projector and your computer with a USB cable before use. (See page 17.)
- ⑧ **POINT (▲▼◀▶) button**  
Selects an item or adjusts value in the On-Screen Menu. These are also used to pan the image in the Digital zoom +/- mode. (p34)  
Point ◀▶ button are also used as VOLUME +/- buttons. (p26)
- ⑨ **PRESENTATION POINTER button**  
Move a pointer of the projector or a pointer for wireless mouse operation. (p12)
- ⑩ **MENU button**  
Opens or closes the On-Screen Menu. (p22)
- ⑪ **KEystone button**  
Corrects keystone distortion. (p25, 42)
- ⑫ **SELECT button**  
Executes the item selected, or to expand or compress image in the Digital zoom +/- mode. (p34)
- ⑬ **LASER button**  
Operates the Laser pointer function. Laser beam is emitted while pressing this button within 1 minute. When using this laser pointer for more than 1 minute, release the LASER button and press it again. This button is also used as a switching button to activate the Pointer function of the projector. (p12)
- ⑭ **POWER ON-OFF button**  
Turns the projector on or off. (p20, 21)
- ⑮ **NO SHOW button**  
Turns the picture into black image. (p25)
- ⑯ **P-TIMER button**  
Operates P-Timer function. (p26)
- ⑰ **MUTE button**  
Mutes sound. (p26)
- ⑱ **AUTO SET button**  
Corrects vertical keystone distortion and adjusts PC display parameters. (p24, 42)
- ⑲ **R-CLICK button**  
Acts as right click for wireless mouse operation. (p13)
- ⑳ **COMPUTER button**  
Selects input source (COMPUTER 1 or COMPUTER 2). (p27, 36)
- ㉑ **VIDEO button**  
Selects input source (VIDEO). (p35)
- ㉒ **RESET/ON/ALL-OFF switch**  
When using the remote control, set this switch to "ON." Set it to "ALL OFF" for power saving when it is not used. Slide this switch to "RESET" to initialize the remote control code or switch Spotlight and Pointer back to Laser pointer. (p12, 14)

## Laser Pointer Function

This remote control emits a laser beam from the laser light window. With the LASER button pressed, laser light goes on. The signal emission indicator lights red and laser is emitted with red light. With the LASER button pressed for more than 1 minute or released, the light goes off.

The laser emitted is a class II laser. Do not look into the laser light window or shine the laser beam on yourself or other people. Below are the caution labels for laser beam.

**CAUTION :** Use of controls, adjustments or performance of procedures other than those specified herein may result in hazardous radiation exposure. Do not look into the laser light window while laser is emitted, otherwise eye damage may result.

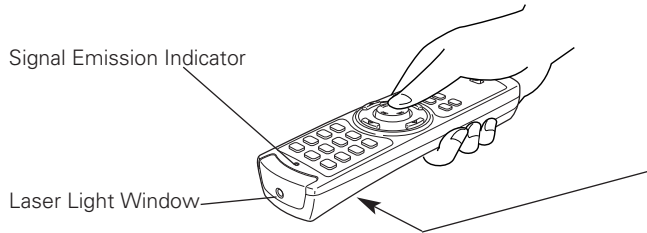

These caution labels are put on the remote control.



## Pointer Function

You can move Spotlight or Pointer of the projector with the remote control to emphasize a part of the projected image.

- 1 With pressing the MENU button, hold down the NO SHOW button for more than 7 seconds so that the Pointer function will be available. (The Laser pointer has switched to the Pointer.)
- 2 Press the LASER button on the remote control toward the projector. Spotlight or Pointer is displayed on the screen with the LASER button lighting green. Then move the Spotlight or Pointer with the PRESENTATION POINTER button. If the LASER button does not light green and still emits laser beam, try the procedure above until the LASER button lights green.
- 3 To clear the Spotlight or Pointer out the screen, press the LASER button toward the projector and see if the LASER button lighting turns off. To switch back to the Laser pointer again, hold down the NO SHOW button with pressing the MENU button for more than 7 seconds or slide the RESET/ON/ALL-OFF switch to "RESET". (p11)

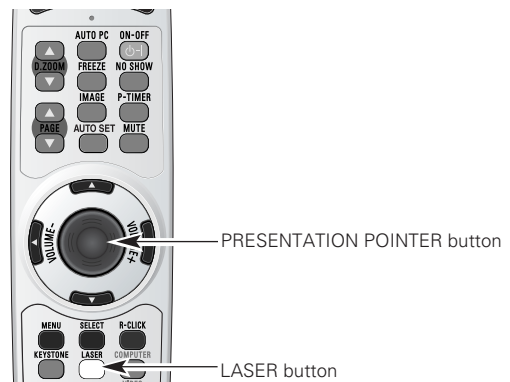
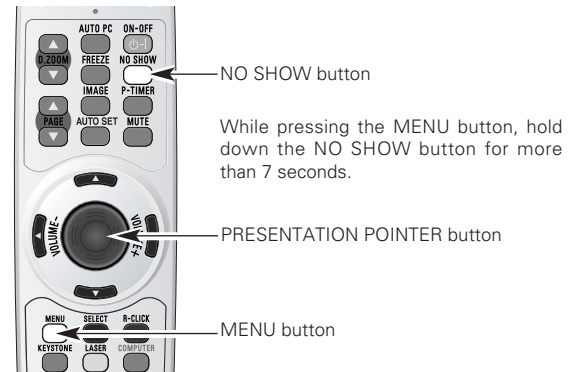

Spotlight

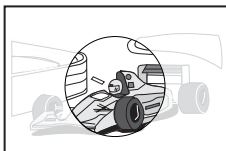

Pointer

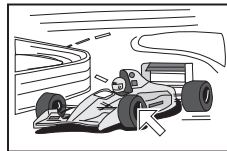

**Note:**

You can choose the size of Spotlight (Large, Middle, and Small) and the pattern of Pointer (Arrow, Finger, and Dot) in the Setting Menu. See "Pointer" on page 46.

After the Laser pointer has switched to the Pointer, use the LASER button as the Pointer function ON-OFF switch. Press the LASER button toward the projector and see if it lights green.

## Wireless Mouse Operation

The remote control can be used as a wireless mouse for your computer. Before operating the wireless mouse, connect your computer and the projector with the supplied USB cable. (See page 17 for connection.)  
When the Pointer function is used, the wireless mouse is not available.



## Operating Range

Point the remote control toward the projector (Infrared Remote Receiver) whenever pressing any button. Maximum operating range for the remote control is about 16.4' (5m) and 60° in front of the projector.

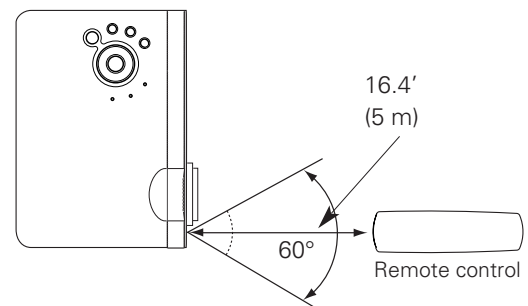

## Remote Control Code

This projector has eight different remote control codes (Code 1-Code 8). Switching remote control codes prevents remote control interference when operating several projectors or video equipment at the same time. Change the remote control code for the projector first before changing that for the remote control. See "Remote control" in Setting on page 46.

- 1 With holding down the MENU button, press the IMAGE button. The code switches sequentially for one pressing the IMAGE button. (See the list below.)
- 2 To initialize the remote control code, slide the RESET/ON/ALL-OFF switch to RESET, and then to ON. The initial code is Code 1. (p11)

Remote Control Code	Number of Times of Pressing IMAGE Button
Code 1	1
Code 2	2
Code 3	3
Code 4	4
Code 5	5
Code 6	6
Code 7	7
Code 8	8

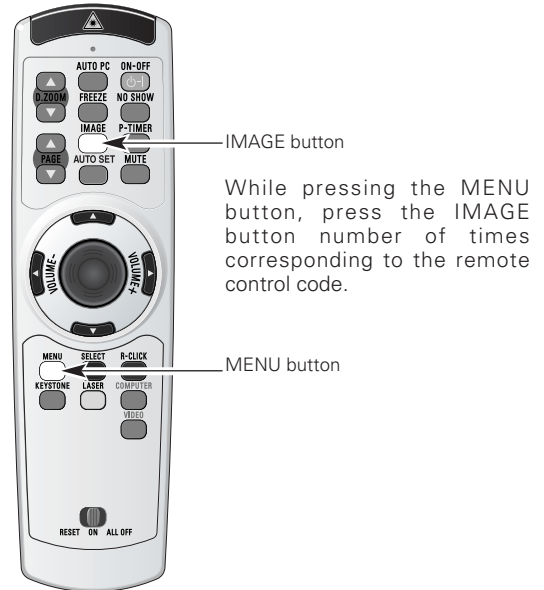

## Remote Control Battery Installation

- 1 Remove the battery compartment lid.

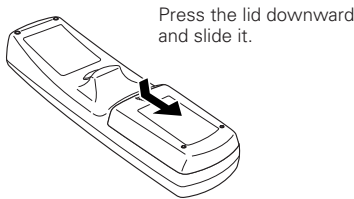

- 2 Slide the batteries into the compartment.

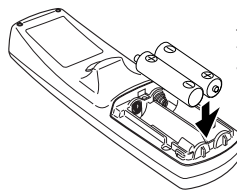

- 3 Replace the compartment lid.

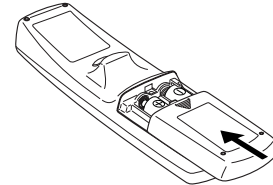

To insure safe operation, please observe the following precautions :

- Use (2) AA, UM3 or LR6 type alkaline batteries.
- Replace two batteries at the same time.
- Do not use a new battery with a used battery.
- Avoid contact with water or liquid.
- Do not expose the remote control to moisture, or heat.
- Do not drop the remote control.
- If a battery has leaked on remote control, carefully wipe case clean and install new batteries.
- Risk of explosion if battery is replaced by an incorrect type.
- Dispose of used batteries according to the instructions.

## Positioning the Projector

This projector is designed to project on a flat projection surface and can be focused from 3.3'(1.0m) - 25.3'(7.7m). Refer to the figure and the table below for the screen size and the distance between the projector and the screen.

$$A : B = 9 : 1$$

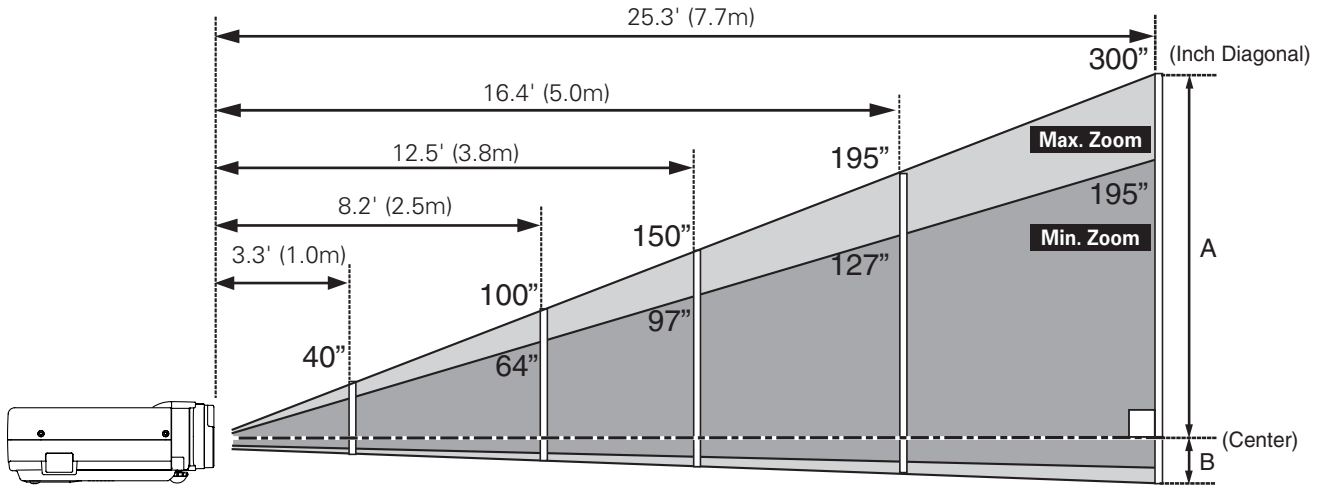

Screen Size (W x H) mm	40"	100"	150"	195"	300"
4 : 3 aspect ratio	813 x 610	2032 x 1524	3048 x 2286	3962 x 2972	6096 x 4572
Zoom (min)	4.9' (1.5m)	12.8' (3.9m)	19.3' (5.9m)	25.3' (7.7m)	—
Zoom (max)	3.3' (1.0m)	8.2' (2.5m)	12.5' (3.8m)	16.4' (5.0m)	25.3' (7.7m)

**✓ Note:**

- The brightness in a room has a great influence on picture quality. It is recommended to limit ambient lighting in order to obtain the best image.
- The values shown above are approximate and may vary from the actual size.

## Adjustable Feet

Projection angle can be adjusted up to 11.8 degrees with the adjustable feet.

- 1** Lift the front of the projector and pull upward the feet lock latches on both sides of the projector.
- 2** Release the feet lock latches to lock the adjustable feet and rotate the adjustable feet to adjust the position and tilt.
- 3** To retract the adjustable feet, lift the front of the projector and pull and undo the feet lock latches.  
Keystone distortion of the projected image can be adjusted automatically with Auto Setup function or manually with the remote control or the menu operation. (p24, 25, and 42)

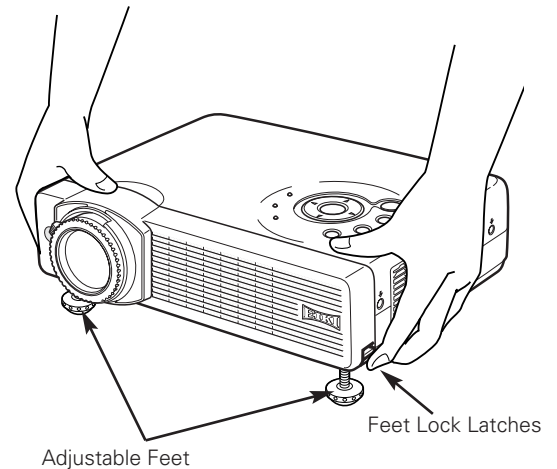

## Connecting the AC Power Cord

This projector uses nominal input voltages of 100-120 V or 200-240 V AC. This projector automatically selects the correct input voltage. It is designed to work with single-phase power systems having a grounded neutral conductor. To reduce risk of electrical shock, do not plug into any other type of power system.

Consult your authorized dealer or service station if you are not sure of the type of power being supplied.

Connect the projector with all peripheral equipment before turning the projector on. (See page 17-19 for connection.)



### CAUTION

For safety, unplug AC power cord when the projector is not in use. When this projector is connected to an outlet with AC power cord, it is in Stand-by mode and consumes a little electric power.

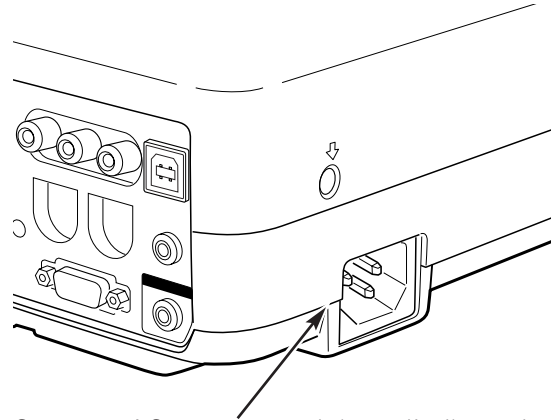

Connect AC power cord (supplied) to the projector.

The AC outlet must be near this equipment and must be easily accessible.

### NOTE ON THE POWER CORD

The AC Power Cord must meet the requirement of the country where you use the projector. Confirm the AC plug type with the chart below. The proper AC Power Cord must be used. If the supplied AC Power Cord does not match the AC outlet, contact your sales dealer.

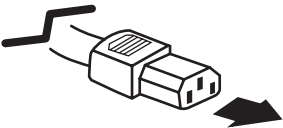
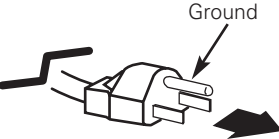
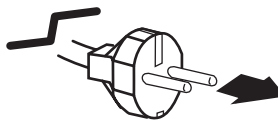
Projector side	AC Outlet side	
 <p data-bbox="381 1312 592 1386">To the POWER CORD CONNECTOR on the projector.</p>	<p data-bbox="673 1113 966 1144"><b>For the U.S.A. and Canada</b></p>  <p data-bbox="836 1165 885 1186">Ground</p> <p data-bbox="803 1312 966 1375">To the AC Outlet. <b>(120 V AC)</b></p>	<p data-bbox="1047 1113 1347 1144"><b>For Continental Europe</b></p>  <p data-bbox="1177 1344 1356 1396">To the AC Outlet. <b>(200 - 240 V AC)</b></p>

## Connecting to a Computer

### Cables used for connection

- VGA Cable (HDB 15 pin) \*
  - DVI-VGA Cable (HDB 15 pin)
  - USB Cable
  - Audio Cables (Mini Plug; stereo) \*
- (\* = Not supplied with this projector.)

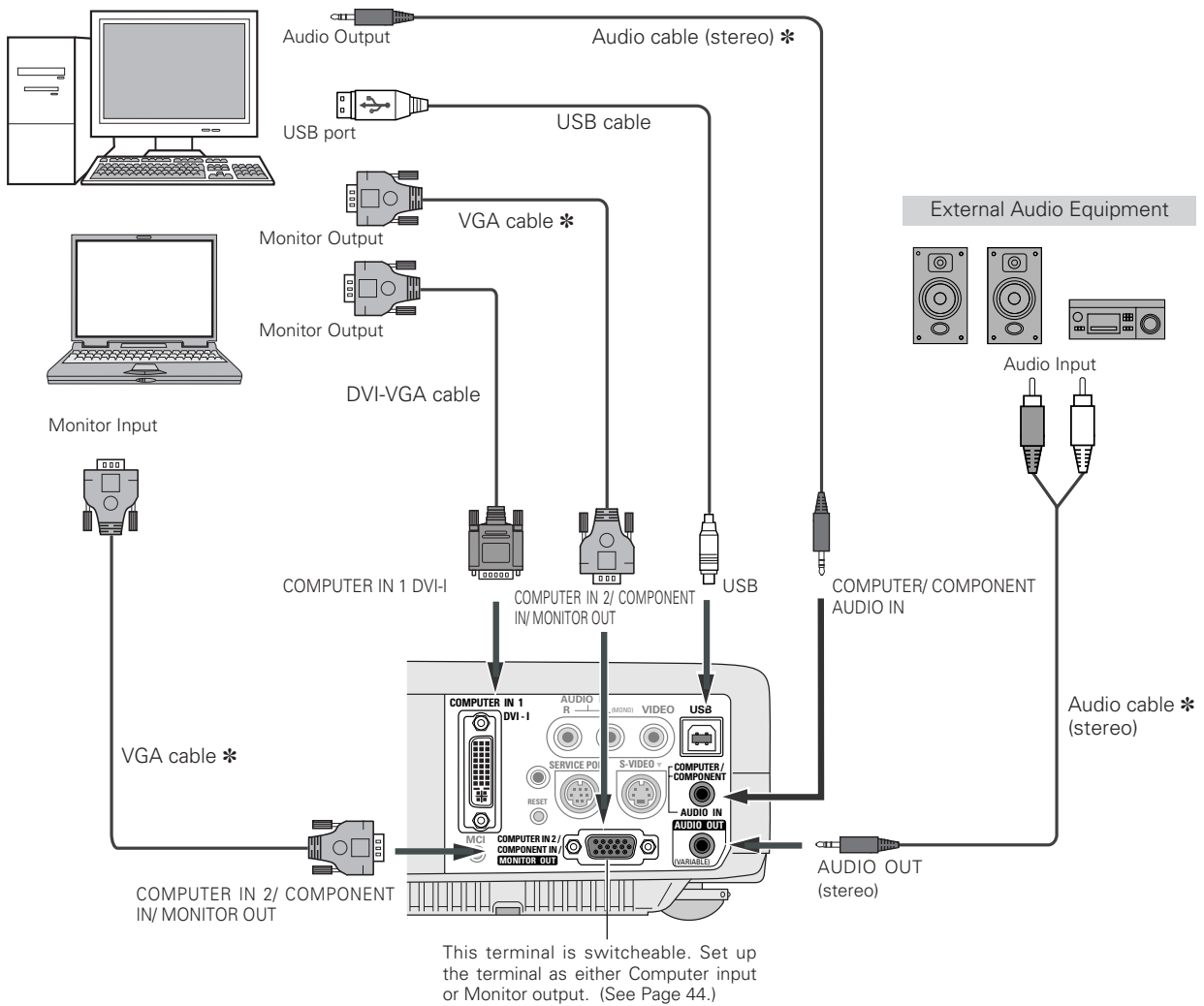

**✓ Note:**  
When connecting AUDIO OUT to external audio equipment, the projector's built-in speaker is disconnected.

**⚠ Note:**  
When connecting the cable, the power cords of both the projector and the external equipment should be disconnected from AC outlet.

## Connecting to Video Equipment

### Cables used for connection

- Video and Audio Cable (RCA x 3) \*
  - S-VIDEO Cable \*
  - Audio Cables (Mini Plug; stereo) \*
- (\* = Not supplied with this projector.)

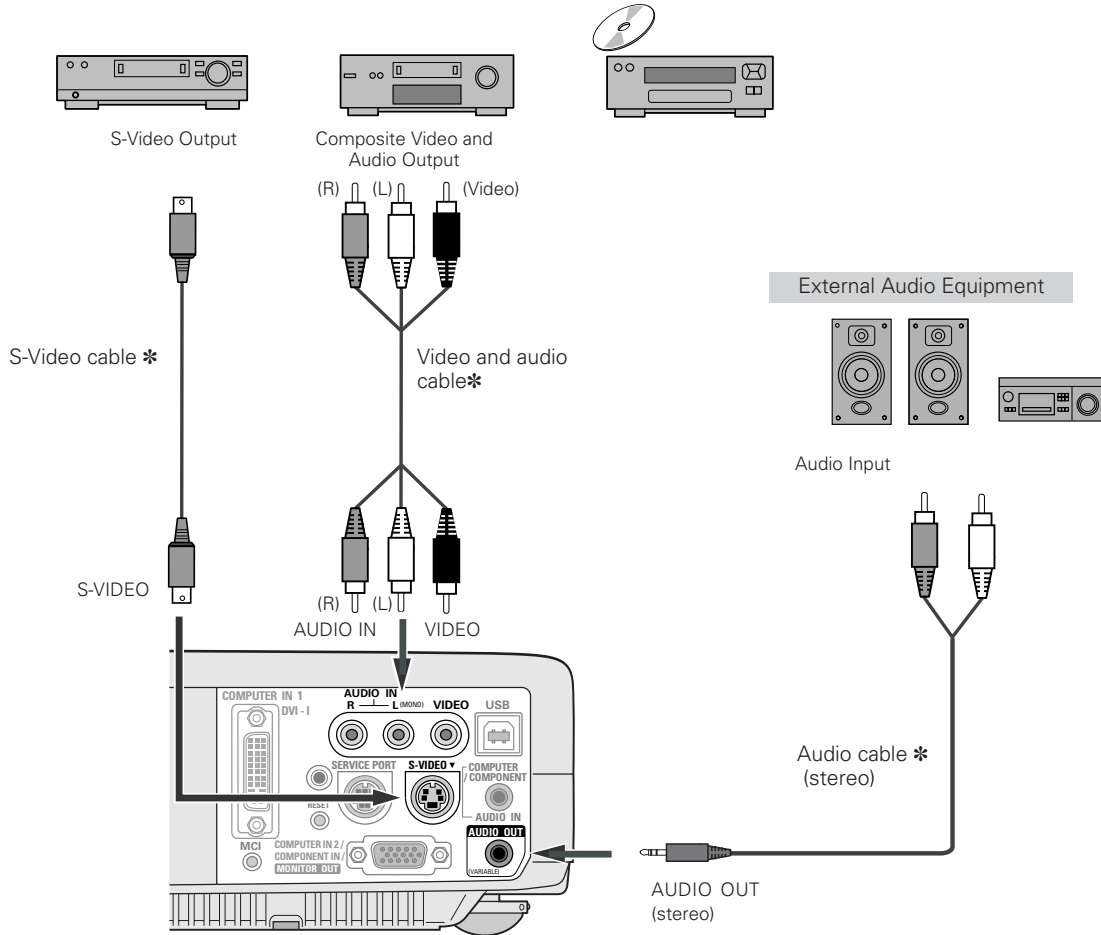

✓ **Note:**

- The S-VIDEO jack has priority over the VIDEO jack under the condition of connecting both the S-VIDEO jack and the VIDEO jack when selecting AUTO in the Input Menu.
- Input sound to the COMPUTER/COMPONENT AUDIO IN terminal when using the COMPUTER IN 2/COMPONENT IN/MONITOR OUT terminal as input.
- When connecting AUDIO OUT to external audio equipment, the projector's built-in speaker is disconnected.



**Note:**

When connecting the cable, the power cords of both the projector and the external equipment should be disconnected from AC outlet.

## Connecting to Component Video Equipment

### Cables used for connection

- Audio Cables (Mini Plug (stereo) x 2 or RCA x 2) \*
- Scart-VGA Cable \*
- Component-VGA Cable \*

(\* = Not supplied with this projector.)

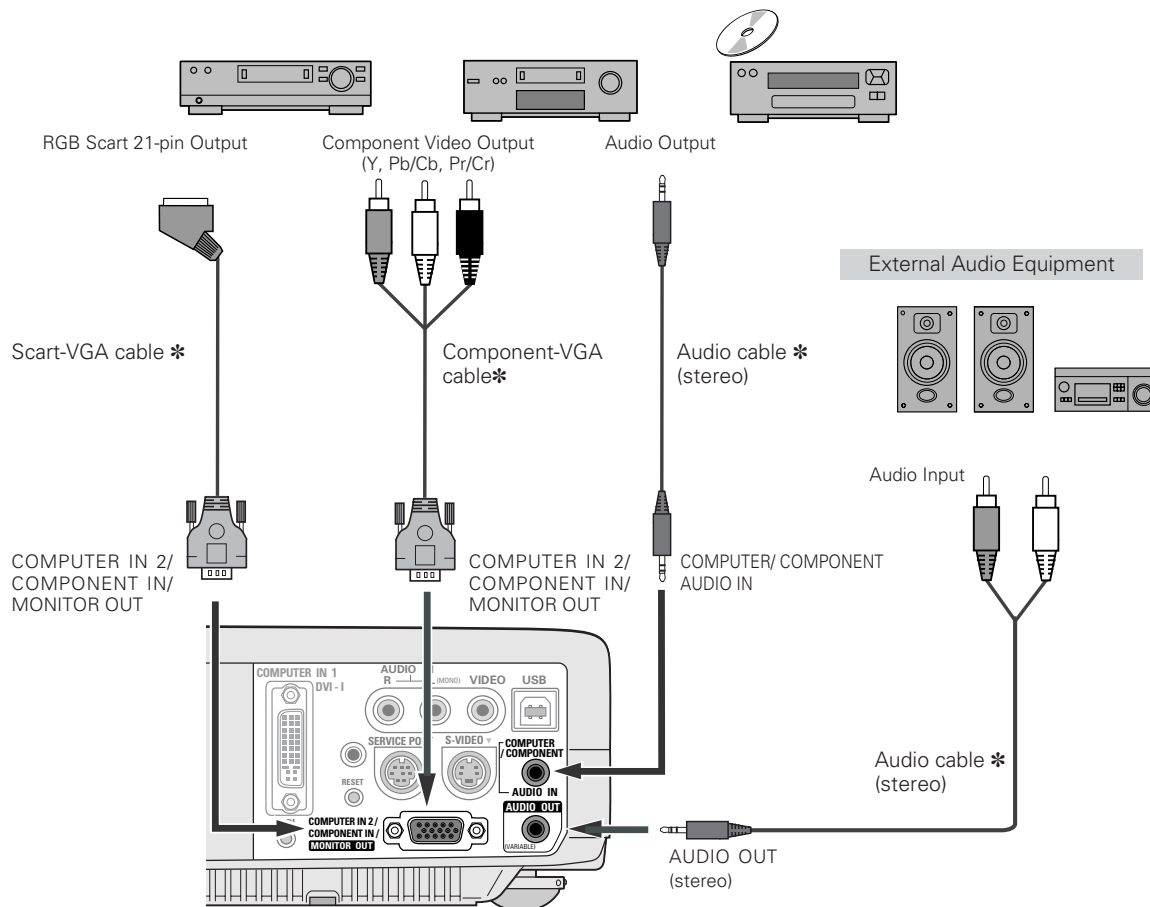

**✓ Note:**

- Input sound to the *COMPUTER/COMPONENT AUDIO IN* terminal when using the *COMPUTER IN 2/COMPONENT IN/MONITOR OUT* terminal as input.
- When connecting *AUDIO OUT* to external audio equipment, the projector's built-in speaker is disconnected.



**Note:**

When connecting the cable, the power cords of both the projector and the external equipment should be disconnected from AC outlet.

# Basic Operation

## Turning On the Projector

- 1 Complete peripheral connections (with a computer, VCR, etc.) before turning on the projector.
- 2 Connect the projector's AC power cord into an AC outlet. The POWER indicator blinks red in a moment and lights red.
- 3 Press the POWER ON-OFF button on the top control or on the remote control. The POWER indicator turns green lighting and the cooling fans start to operate. The preparation display appears on the screen and the count down starts.
- 4 After the count-down, the input source that was selected last and the Lamp mode status icon (see page 45) appear on the screen.

If the projector is locked with a PIN code, PIN code Input Dialog Box will appear. Enter the PIN code as instructed below.

### Enter a PIN code

Select a number by pressing the Point ◀▶ button and fix the number with the SELECT button. The number will change to "\*". If you fixed a wrong number, move the pointer to "Set" or "Clear" once by pressing the Point ▼ button, then return to "PIN code". Enter the correct number again. Repeat this step to complete entering a four-digit number.

When the four-digit number is fixed, the pointer will automatically move to "Set". Press the SELECT button so that you can start to operate the projector.

If you entered a wrong PIN code, "PIN code" and the number (\*\*\*\*) will turn red and disappear. Enter a correct PIN code all over again.

### What is PIN code?

PIN code is a security code using Personal Identification Number that allows the person who knows it to operate the projector. Setting PIN code prevents others except the specific users from operating the projector.

A PIN code consists of a four-digit number. Refer to PIN Code Lock function in Setting on page 47 for locking operation of the projector with your PIN code.



#### CAUTION ON HANDLING PIN CODE

If you forget your PIN code, the projector can no longer be started. Set a new PIN code with special care, write it down in column on page 63 of this manual, and keep it at hand. Should the PIN code be missing or forgotten, consult your dealer or service center.



The preparation display disappears after 20 seconds.

### Selected Input Source and Lamp Mode

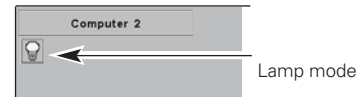

(See page 45 for Lamp mode.)

### PIN code Input Dialog Box

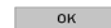

After the OK icon disappears, you can operate the projector.

## Turning Off the Projector

- 1 Press the POWER ON-OFF button on the top control or on the remote control, and a message "Power off?" appears on the screen.
- 2 Press the POWER ON-OFF button again to turn off the projector. The POWER indicator starts to blink red, and it continues while the cooling fans are operating for about 90 seconds. (About 120 seconds when the fan mode is L2. See page 48.)
- 3 When the projector has cooled down enough to be turned on again, the POWER indicator lights red. Then you can disconnect the AC power cord.

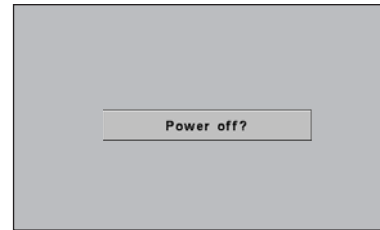

The message disappears after 4 seconds.



TO MAINTAIN THE LIFE OF LAMP, ONCE YOU TURN PROJECTOR ON, WAIT AT LEAST 5 MINUTES BEFORE TURNING IT OFF. DO NOT DISCONNECT AC POWER CORD WHILE COOLING FANS ARE RUNNING OR BEFORE POWER INDICATOR LIGHTS RED. OTHERWISE IT WILL RESULT IN SHORTENING LAMP LIFE.

### ✓ Note:

- The projector cannot be turned on during the cooling period with the POWER indicator blinking red. You can turn it on again after the POWER indicator lights red.
- When the On start function is on, this projector is turned on automatically by connecting the AC power cord to an AC outlet. (See page 45 for the On start function.)
- Do not operate the projector continuously without rest. Continuous use may result in shortening the lamp life. Turn off the projector and give it a rest about an hour in every 24 hours.
- This projector monitors internal temperature and automatically controls the running speed of the cooling fans.
- If the WARNING indicator blinks or lights red, see "Warning Indicator" on page 49.

## How to Operate the On-Screen Menu

The projector can be adjusted or set via the On-Screen Menu. Refer to the following pages regarding each adjustment and setting procedure.

- 1 Press the MENU button to display the On-Screen Menu.
- 2 Press the Point ◀▶ buttons to select a Menu icon to adjust. Press the Point ▲▼ buttons to select an item to adjust.
- 3 Press the SELECT button to show the item data. Press the Point ◀▶ buttons to adjust the data. Refer to the following pages for respective adjustment.

✓ **Note:**

The selected item is not in effective until the SELECT button is pressed.

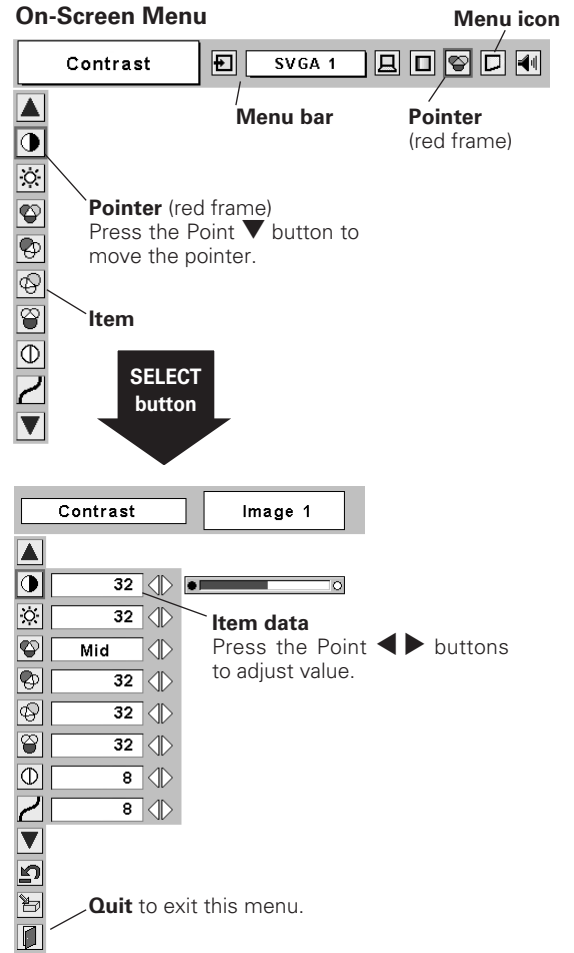

### Remote Control

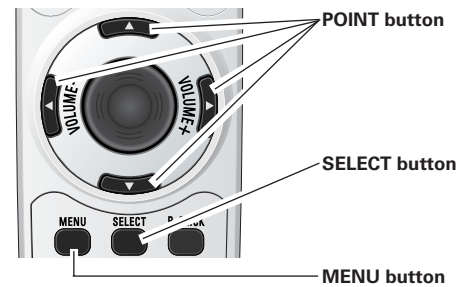

### Top Control

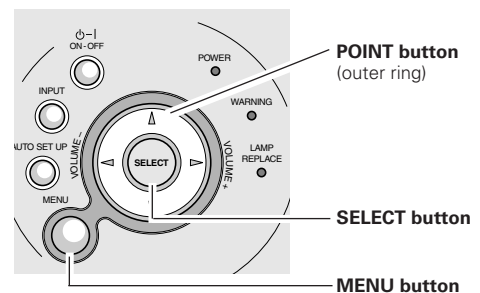

## Menu Bar

### For computer source

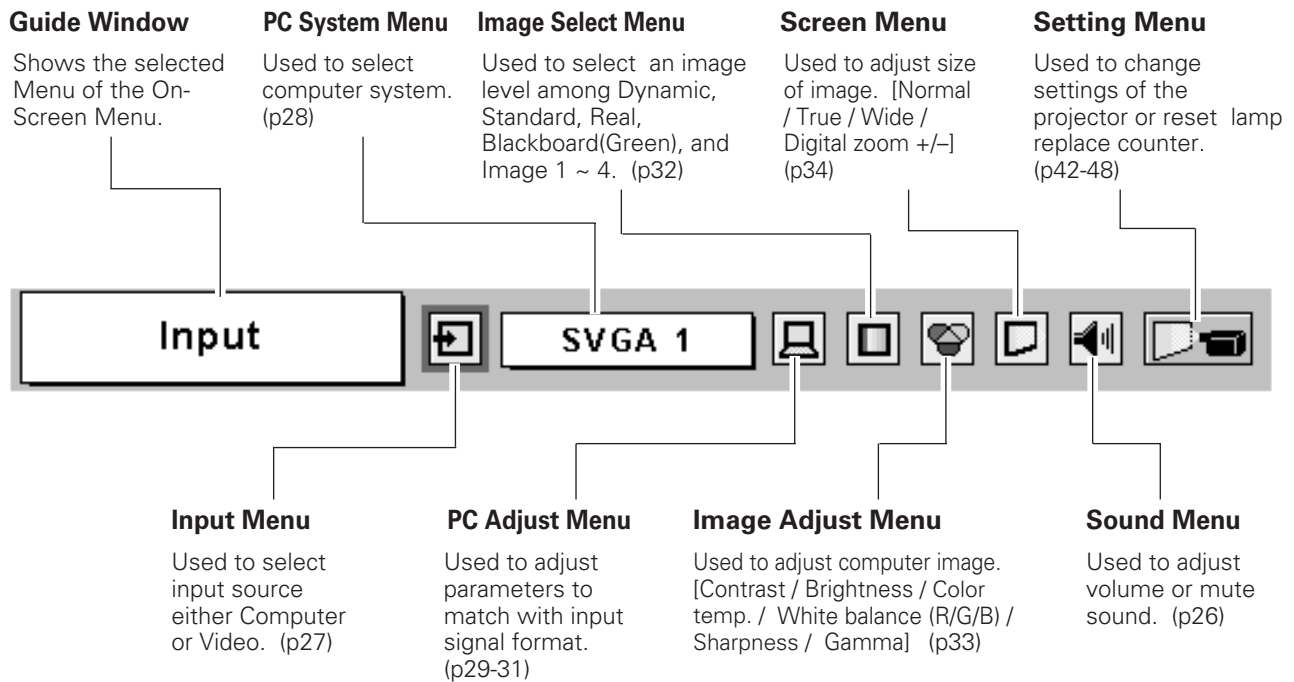

### For video source

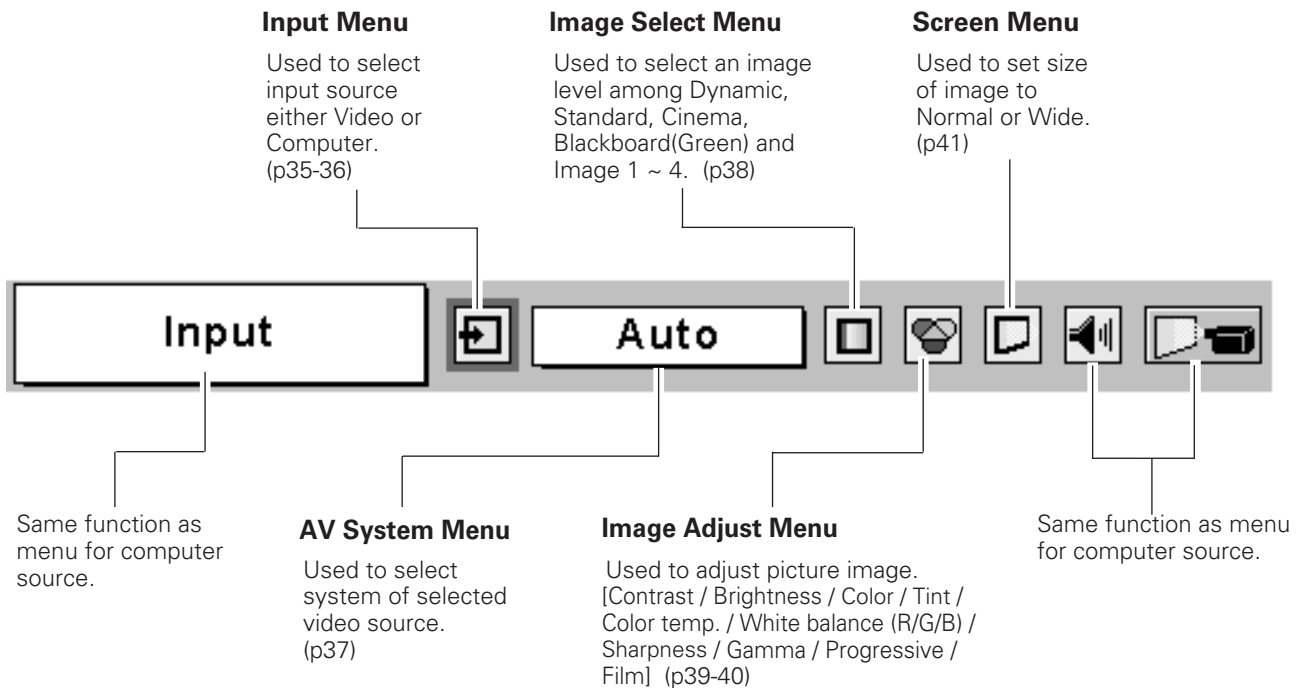

## Zoom and Focus Adjustment

Rotate the Zoom Lever to zoom in and out.  
Rotate the Focus Ring to adjust the projected picture focus.

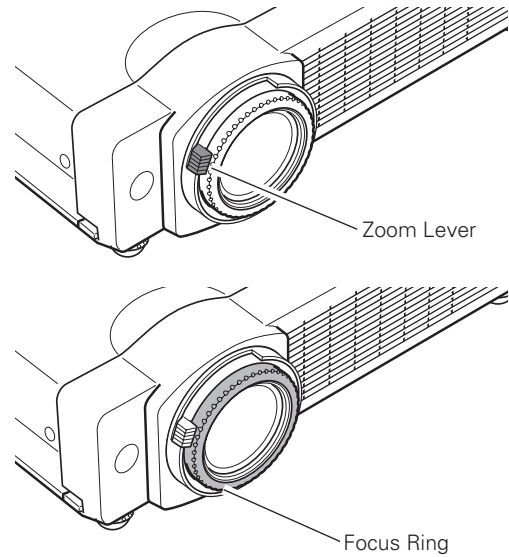

## Auto Setup Function

Auto Set Up function is provided to automatically correct Keystone distortion according to the projector's tilt and adjust the computer display parameters (Fine sync, Total dots and Picture position) by just pressing the AUTO SETUP button on the top control or the AUTO SET button on the remote control. The operational setup for the Auto Setup can be changed in the Setting menu. Refer to p42 on setting of the Auto Setup function.

✓ **Note:**

- Auto Keystone corrects vertical distortion only, not correct horizontal distortion.
- Auto Keystone cannot work when Ceiling feature is On in the Setting menu. (p44)
- Perfect correction of the image distortion cannot be ensured with the Auto Setup function. If the distortion cannot be corrected properly by pressing the AUTO SETUP/ AUTO SET button, adjust manually by pressing the KEYSTONE button on the remote control or selecting Keystone in the Setting menu. (p25, 42)

### Remote Control

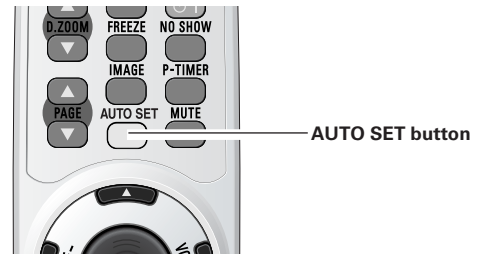

### Top Control

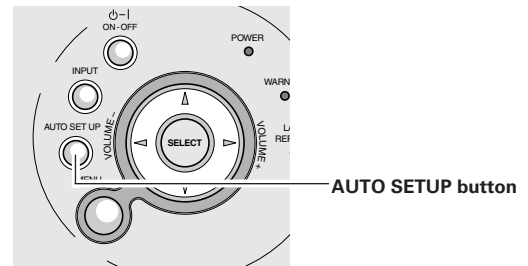

## Keystone Adjustment

If a projected picture still has keystone distortion after pressing the AUTO SETUP button on the top control or the AUTO SET on the remote control, correct the image manually as follows:

- 1 Press the KEYSTONE button on the remote control or select Keystone in the Setting Menu (p42). The keystone dialog box appears.
- 2 Correct keystone distortion by pressing the Point ▲▼◀▶ button. Keystone adjustment can be memorized. (p42)



- The arrows are white when there is no correction.
- The arrows disappear at the maximum correction.
- The direction of the arrow being corrected turns red.
- If you press the KEYSTONE button on the top control or on the remote control once more while the keystone dialog box is being displayed, the keystone adjustment will be canceled.

Reduce the upper width with Point ▲ button.

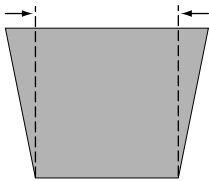

Reduce the lower width with Point ▼ button.

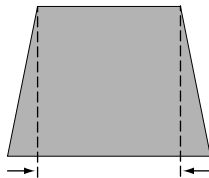

Reduce the left part with Point ◀ button.

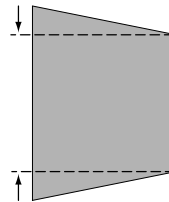

Reduce the right part with Point ▶ button.

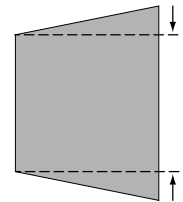

## Picture Freeze Function

Press the FREEZE button on the remote control to freeze the picture on the screen. To cancel FREEZE, press the FREEZE button again or press any other button. (p11)

## No Show Function

Press the NO SHOW button on the remote control to black out the image. To restore to normal, press the NO SHOW button again or press any other button. When a projected image is captured and set as "User" in the Logo item in the Setting Menu (p44), the screen changes each time you press the NO SHOW button as follows.

black out → the captured image → normal → .....



The message disappears after 4 seconds.

## P-Timer Function

Press the P-TIMER button on the remote control. The timer display "00 : 00" appears on the screen and the timer starts to count time (00 : 00 ~ 59 : 59).

To stop the P-Timer, press the P-TIMER button. And then, press the P-TIMER button again to cancel the P-Timer function.



## Sound Adjustment

### Direct Operation

#### Volume

Press the VOLUME (+/-) button on the top control or on the remote control to adjust volume. The volume dialog box appears on the screen for a few seconds.

(+) button to turn up the volume and (-) button to turn down the volume.

#### Mute

Press the MUTE button on the remote control to cut off sound. To restore sound to its previous level, press the MUTE button again or press the VOLUME (+/-) button.

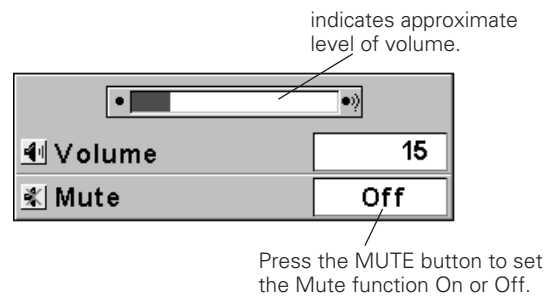

The display disappears after 4 seconds.

### Menu Operation

1 Press the MENU button and the On-Screen Menu will appear. Press the Point ◀▶ button to move the red frame pointer to the Sound Menu icon.

2 Press the Point ▼ button to move the red frame pointer to the item that you want to select, and then press the SELECT button.

#### Volume

Press the Point ▶ button to turn up the volume, and press the Point ◀ button to turn down the volume.

#### Mute

Press the Point ◀▶ button to cut off sound. Dialog box display is changed to "On" and sound is cut off. To restore sound to its previous level, press the Point ◀▶ button again.

### Sound Menu

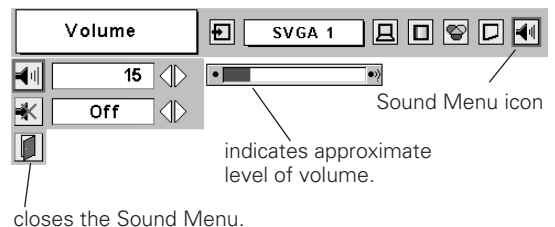

## Input Source Selection

### Direct Operation

Choose either Computer 1 or Computer 2 by pressing the INPUT button on the top control or press the COMPUTER button on the remote control.

Before using these buttons, correct input source should be selected through menu operation as described below.

### INPUT button

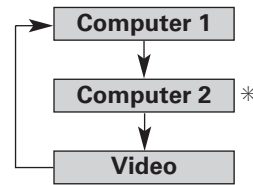

### COMPUTER button

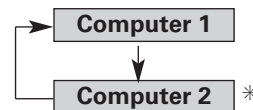

\* See Note on the bottom of this page.

### Menu Operation

- 1 Press the MENU button and the On-Screen Menu will appear. Press the Point ◀▶ button to move the red frame pointer to the Input Menu icon.
- 2 Press the Point ▼ button to move the red arrow pointer to either Computer 1 or Computer 2, and then press the SELECT button.
- 3 After the Source Select Menu appears for Computer 1, move the pointer to RGB and then press the SELECT button.

**RGB (Analog)** When the input source is analog coming from a computer through the DVI terminal, select RGB (Analog).

**RGB (PC Digital)** When the input source is digital coming from a computer through the DVI terminal, select RGB (PC Digital)

**RGB (AV HDCP)** When the input source compatible with HDCP is coming from video equipment through the DVI terminal, select RGB (AV HDCP).

**RGB** When the input source is analog coming from a computer through the COMPUTER IN 2/COMPONENT IN/MONITOR OUT terminal, select RGB.

### ✓ Note:

- Computer 2 is not displayed when the COMPUTER IN 2/COMPONENT IN/ MONITOR OUT terminal is set as Monitor out. (p44)
- HDCP (High-bandwidth Digital Content Protection) is a system for protecting digital entertainment content delivered by DVI (Digital Visual Interface) from being copied. The specification of HDCP is decided and controlled by Digital Content Protection, LLC. Should the specification be changed, this projector may not display the digital content protected by HDCP.

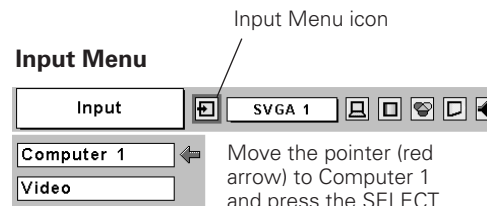

\* See Note on the bottom of this page.

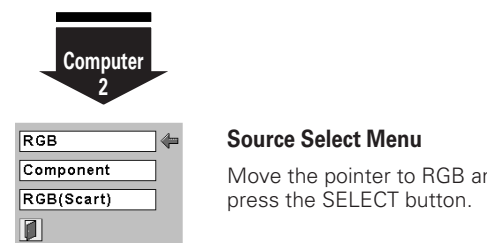
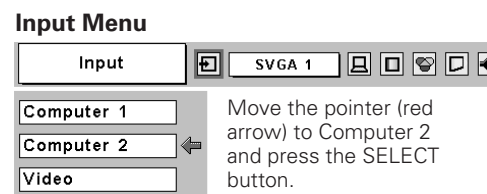
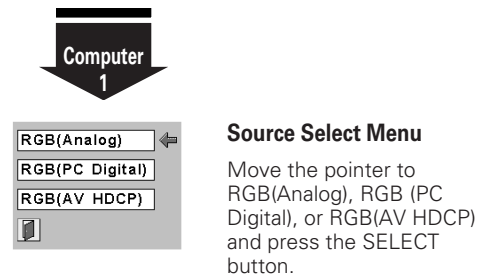

## Computer System Selection

This projector automatically tunes to various types of computers based on VGA, SVGA, XGA or SXGA with its Multi-scan system and Auto PC Adjustment. If Computer is selected as a signal source, this projector automatically detects the signal format and tunes to project a proper image without any additional setting. (Signal formats provided in this projector is shown on page 59)

**✓ Note:**

The projector may display one of the following messages.

**Auto** When the projector cannot recognize connected signal conforming to PC Systems provided in this projector, Auto PC Adjustment function works to display proper images and the message "Auto" is displayed on the PC System menu box. When the image is not projected properly, manual adjustment is required. (p30, 31)

**----** There is no signal input from computer. Check the connection of your computer and the projector. (See "Troubleshooting" p54)

**Mode 1** User preset system manually adjusted in PC Adjust menu. Adjustment data can be stored in Mode 1 - 5. (p30, 31)

**SVGA 1** PC Systems provided in the projector. The projector chooses a proper system and displays it.

\*Mode 1 and SVGA 1 are examples.

### PC System Menu

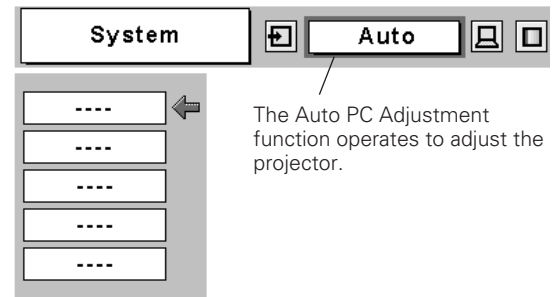

### Selecting Computer System Manually

PC system can also be selected manually.

- 1** Press the MENU button and the On-Screen Menu will appear. Press the Point ◀▶ buttons to move the red frame pointer to the PC System Menu icon.
- 2** Press the Point ▼ button to move the red arrow pointer to the system that you want to set, and then press the SELECT button.

### PC System Menu

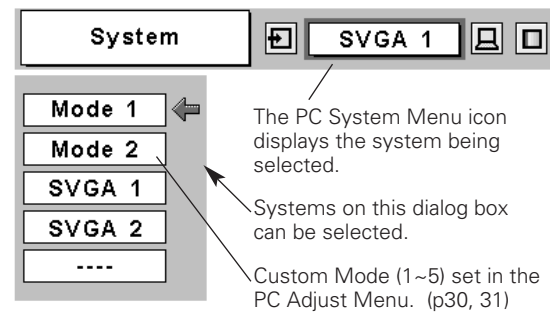

## Auto PC Adjustment

Auto PC Adjustment function is provided to automatically adjust Fine sync, Total dots, Horizontal, and Vertical to conform to your computer. Auto PC Adjustment function can be operated as follows.

### Auto PC Adj.

- 1 Press the MENU button to display the On-Screen Menu. Press the Point ◀▶ button to move the red frame pointer to PC Adjust Menu icon.
- 2 Press the Point ▼ button to move the red frame pointer to Auto PC Adj. icon and then press the SELECT button twice. This Auto PC Adjustment can be also executed by pressing the Auto PC button on the remote control unit.

### To store adjustment parameters

Adjustment parameters from Auto PC Adjustment can be memorized in this projector. Once parameters are memorized, the setting can be done just by selecting Mode in the PC System Menu (p28). See "Store" on page 31.

### ✓ Note:

- Fine sync, Total dots and Picture Position of some computers can not be fully adjusted with this Auto PC Adjustment function. When the image is not provided properly with this operation, manual adjustments are required. (p30, 31)
- The Auto PC Adjust cannot be operated when 480i, 575i, 480p, 575p, 720p, 1035i, or 1080i is selected in the PC System Menu.

### PC Adjust Menu

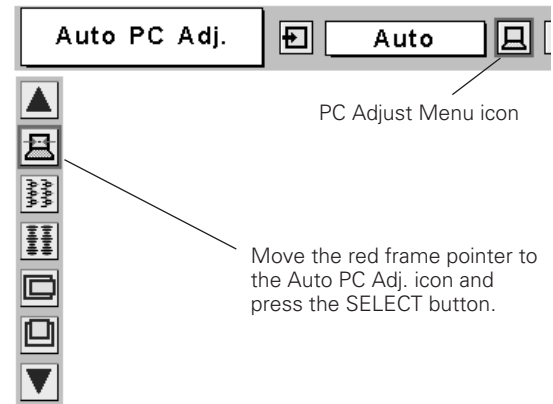

## Manual PC Adjustment

Some computers employ special signal formats which may not be tuned by Multi-scan system of this projector. Manual PC Adjustment enables you to precisely adjust several parameters to match those signal formats. The projector has 5 independent memory areas to memorize those parameters manually adjusted. It allows you to recall the setting for a specific computer.

- 1 Press the MENU button and the On-Screen Menu will appear. Press the Point ◀▶ button to move the red frame pointer to the PC Adjust Menu icon.
- 2 Press the Point ▼ button to move the red frame pointer to the item that you want to adjust and then press the SELECT button. An adjustment dialog box will appear. Press the Point ◀▶ button to adjust value.

### Fine sync

Eliminates flicker from the image displayed. Press the Point ◀▶ button to adjust value. (From 0 to 31)

### Total dots

Adjusts the number of total dots in one horizontal period. Press the Point ◀▶ button and adjust number to match your PC image.

### Horizontal

Adjusts horizontal picture position. Press the Point ◀▶ button to adjust the position.

### Vertical

Adjusts vertical picture position. Press the Point ◀▶ button to adjust the position.

### Current mode

Press the SELECT button to show H-Freq. and V-Freq. of the connected computer.

### Clamp

Adjusts clamp level. When the image has dark bars, try this adjustment.

PC Adjust Menu icon

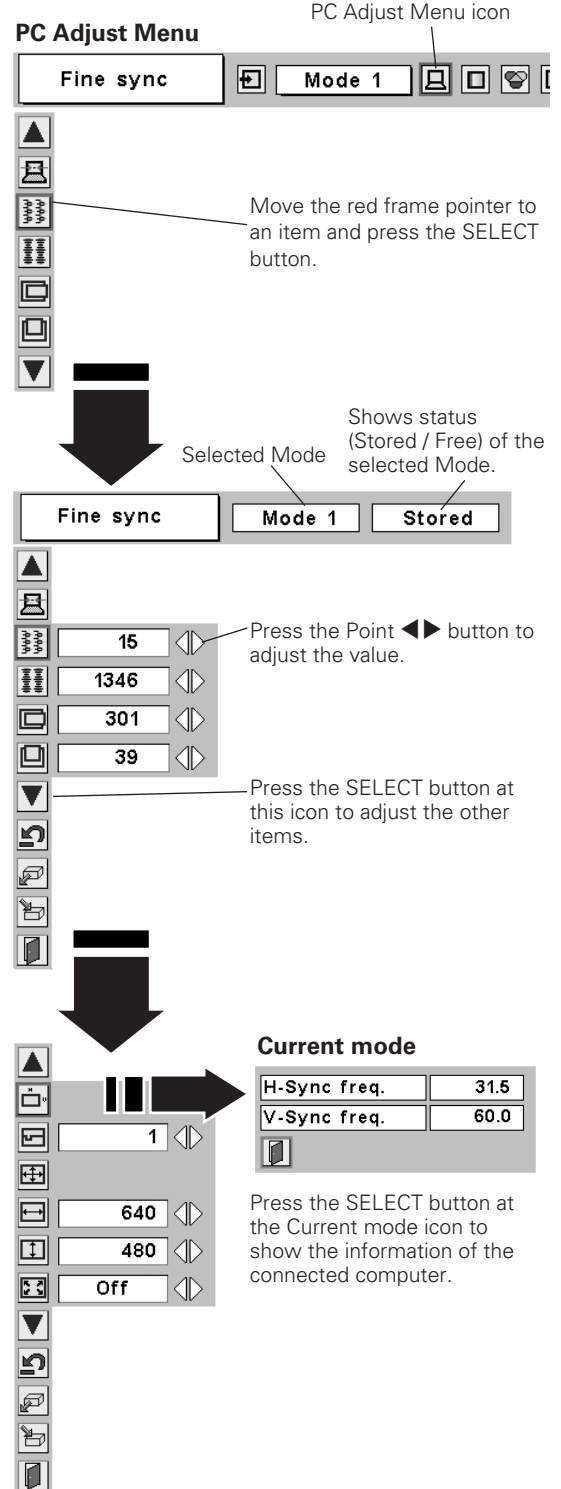

**PC Adjust Menu**

Fine sync Mode 1

Move the red frame pointer to an item and press the SELECT button.

Shows status (Stored / Free) of the selected Mode.

Selected Mode

Fine sync Mode 1 Stored

Press the Point ◀▶ button to adjust the value.

15 1346 301 39

Press the SELECT button at this icon to adjust the other items.

**Current mode**

H-Sync freq.	31.5
V-Sync freq.	60.0

Press the SELECT button at the Current mode icon to show the information of the connected computer.

 **Display area**

Select the resolution at the Display area dialog box.

 **Display area H**

Adjusts the horizontal area displayed by this projector. Press the Point ◀▶ button to decrease/increase value and then press the SELECT button.

 **Display area V**

Adjusts the vertical area displayed by this projector. Press the Point ◀▶ button to decrease/increase value and then press the SELECT button.

 **Full screen**

With this function on, SXGA image is fully displayed at 4 : 3 aspect ratio. It is displayed at 5 : 4 aspect ratio with this function off.

 **Reset**

Resets all adjustment to their previous levels.

 **Store**

To store adjustment data, move the red frame pointer to the Store icon and then press the SELECT button. Move the red arrow pointer to any of Mode 1 to 5 in which you want to store and then press the SELECT button.

 **Mode free**

To clear adjustment data previously set, move the red frame pointer to the Mode free icon and then press the SELECT button. Move the red arrow pointer to the Mode that you want to clear and then press the SELECT button.

 **Quit**

Exits the PC Adjust Menu.

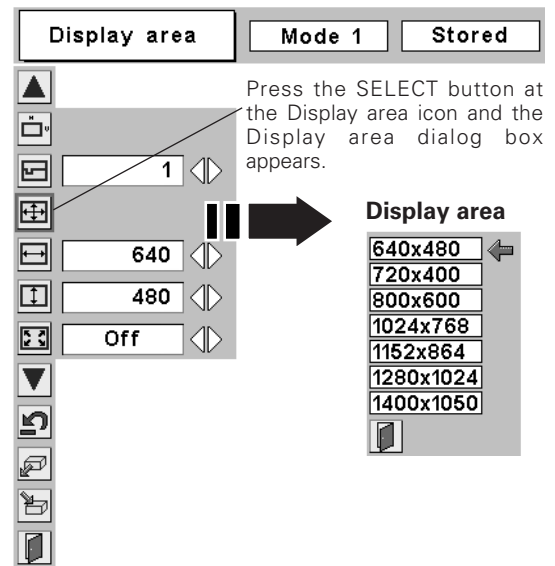

Press the SELECT button at the Display area icon and the Display area dialog box appears.

**To store adjustment data**

This Mode has parameters being stored.

Where to reserve ?

Mode	Status	Total dots	Horizontal	Vertical	Display area H	Display area V
Mode 1	Stored	800	142	34	640	480
Mode 2	Free	800	143	34	640	480
Mode 3	Free	800	143	34	640	480
Mode 4	Free	800	143	34	640	480
Mode 5	Free	800	143	34	640	480

Vacant Mode

shows values of "Total dots," "Horizontal," "Vertical," "Display area H," and "Display area V."

**To clear adjustment data**

Which mode to free ?

Mode	Status	Total dots	Horizontal	Vertical	Display area H	Display area V
Mode 1	Stored	800	142	34	640	480
Mode 2	Free	800	143	34	640	480
Mode 3	Free	800	143	34	640	480
Mode 4	Free	800	143	34	640	480
Mode 5	Free	800	143	34	640	480

closes this dialog box.

**Note:**

Auto PC Adjust, Display area, Display area (H/V), and Full screen cannot be selected when "480i", "575i", "480p", "575p", "720p", "1035i", or "1080i" is selected in the PC System Menu (p28).

## Image Level Selection

### Direct Operation

Select an image level among Dynamic, Standard, Real, Blackboard(Green), Image 1, Image 2, Image 3, and Image 4 by pressing the IMAGE button on the remote control.

#### Dynamic

Picture level suitable for viewing picture in a bright room.

#### Standard

Normal picture level preset on this projector.

#### Real

Picture level with improved halftone for graphics.

#### Blackboard(Green)

Picture level suitable for the image projected on a blackboard (Green).

This mode assists to enhance the image projected on a blackboard. This is mainly effective on a green colored board, not truly effective on a black colored board.

#### Image 1~4

User preset image in the Image Adjust Menu (p33).

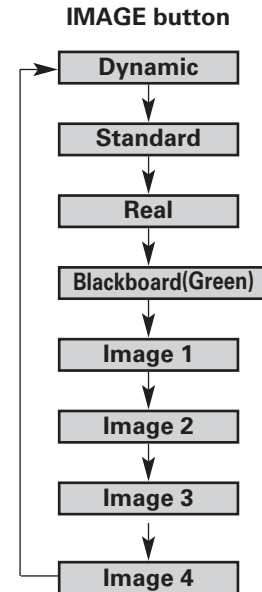

### Menu Operation

- 1 Press the MENU button and the On-Screen Menu will appear. Press the Point ◀▶ button to move the red frame pointer to the Image Select Menu icon.
- 2 Press the Point ▼ button to move the red frame pointer to the level that you want to set and then press the SELECT button.

#### Dynamic

Picture level suitable for viewing picture in a bright room.

#### Standard

Normal picture level preset on this projector.

#### Real

Picture level with improved halftone for graphics.

#### Blackboard(Green)

Picture level suitable for the image projected on a blackboard (Green). See above for further description.

#### Image 1~4

User preset image in the Image Adjust Menu (p33).

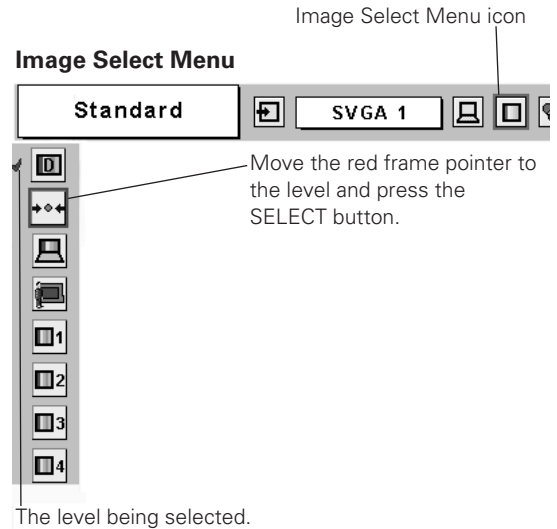

## Image Level Adjustment

- 1 Press the MENU button and the On-Screen Menu will appear. Press the Point ◀▶ button to move the red frame pointer to the Image Adjust Menu icon.
- 2 Press the Point ▼ button to move the red frame pointer to the item that you want to adjust, and then press the SELECT button. The level of each item is displayed. Adjust each level by pressing the Point ◀▶ button.

### Contrast

Press the Point ◀ button to decrease contrast and the Point ▶ button to increase contrast. (From 0 to 63.)

### Brightness

Press the Point ◀ button to adjust image darker and the Point ▶ button to adjust image brighter. (From 0 to 63.)

### Color temp.

Press the Point ◀ button or the Point ▶ button for Color temp. level that you want to select. (XLow, Low, Mid, or High)

### White balance (Red)

Press the Point ◀ button to lighten red tone and the Point ▶ button to deepen red tone. (From 0 to 63.)

### White balance (Green)

Press the Point ◀ button to lighten green tone and the Point ▶ button to deepen green tone. (From 0 to 63.)

### White balance (Blue)

Press the Point ◀ button to lighten blue tone and the Point ▶ button to deepen blue tone. (From 0 to 63.)

### Sharpness

Press the Point ◀ button to soften the image and the Point ▶ button to sharpen the image. (From 0 to 15.)

### Gamma

Press the Point ◀▶ button to obtain better balance of contrast. (From 0 to 15.)

### Reset

Resets all adjustment to their previous levels.

### Store

To store the image data adjusted manually, move the red frame pointer to the Store icon and press the SELECT button. The Image Level Menu will appear. Move the red frame pointer to the Image 1 to 4 where you want to set and then press the SELECT button.

### Quit

Closes the Image Adjust Menu.

### Image Adjust Menu

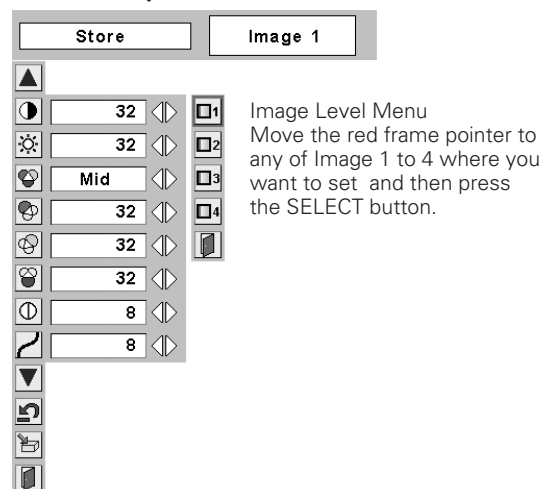
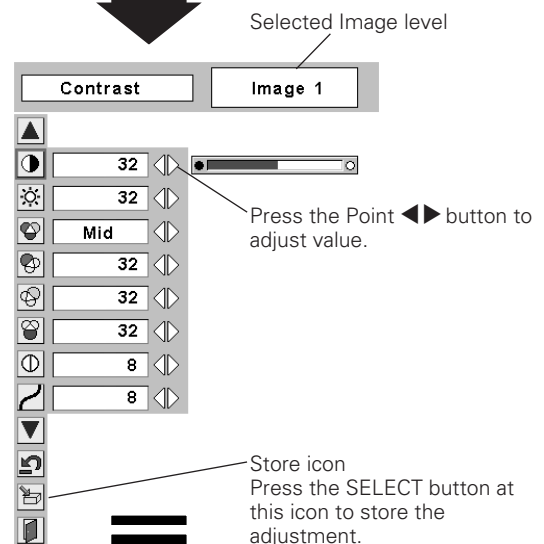
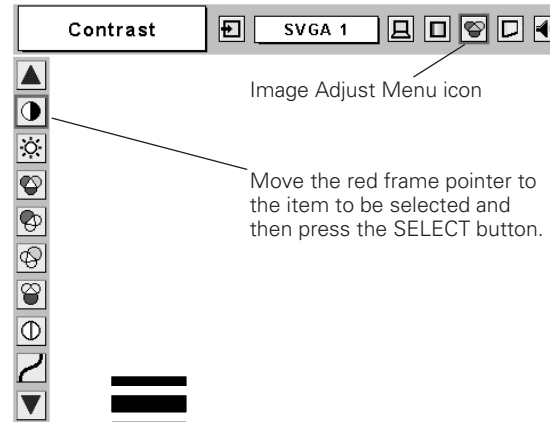

## Screen Size Adjustment

This projector has a picture screen resize function, which enables you to display the desirable image size.

- 1 Press the MENU button and the On-Screen Menu will appear. Press the Point ◀▶ button to move the red frame pointer to the Screen Menu icon.
- 2 Press the Point ▼ button and move the red frame pointer to the function that you want to select and then press the SELECT button.

### Normal

Provides image to fit screen size.

### True

Provides image in its original size. When the original image size is larger than the screen size (1024 x 768), this projector enters "Digital zoom +" mode automatically.

### Wide

Provides image to fit wide video aspect ratio (16 : 9) by expanding image width uniformly. This function can be used for providing a squeezed video signal at 16 : 9.

### Digital zoom +

When the Digital zoom + is selected, the On-Screen Menu disappears and the message "D. Zoom +" is displayed. Press the SELECT button to expand the image size. And press the Point ▲▼◀▶ button to pan the image. The Panning function can work only when the image is larger than the screen size.

A projected image can be also expanded by pressing the D.ZOOM ▲ button on the remote control.

### Digital zoom -

When the Digital zoom - is selected, the On-Screen Menu disappears and the message "D. Zoom -" is displayed. Press the SELECT button to compress the image size.

A projected image can be also compressed by pressing the D.ZOOM ▼ button on the remote control.

To exit the Digital Zoom +/- mode, press any button except the D.ZOOM ▲/▼, SELECT, and Point button.

To return to the normal screen, press the KEYSTONE button twice, press the D.ZOOM ▲▼ button or select Normal from the Screen menu.

### Screen Menu

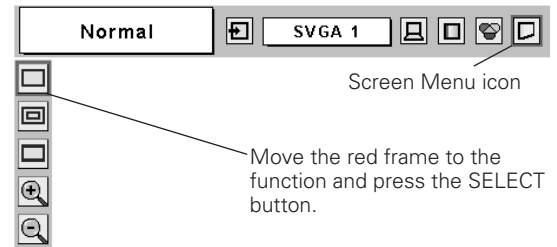

### ✓ Note:

- This Screen Menu cannot be operated when "720p(HDTV)", "1035i (HDTV)", or "1080i (HDTV)" is selected in the PC System Menu (p28).
- The True and Digital zoom +/- cannot be selected when "480i", "575i", "480p", or "575p" is selected in the PC System Menu (p28).
- This projector cannot display any resolution higher than 1280 X 1024. If your computer's screen resolution is higher than 1280 X 1024, reset the resolution to the lower before connecting to the projector.
- The image data in other than XGA (1024 x 768) is modified to fit the screen size in initial mode.
- The panning function may not operate properly if the computer system prepared in the PC Adjust Menu is used.

# Video Input

## Input Source Selection (Video, S-Video)

### Direct Operation

Choose Video by pressing the INPUT button on the top control or the VIDEO button on the remote control.

Before using these buttons, correct input source should be selected through menu operation as described below.

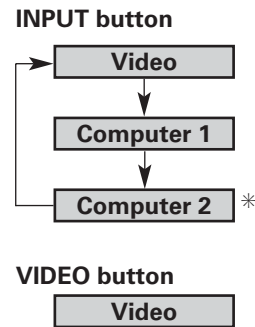

\* See Note on the bottom of this page.

### Menu Operation

- 1 Press the MENU button and the On-Screen Menu will appear. Press the Point ◀▶ button to move the red frame pointer to the Input Menu icon.
- 2 Press the Point ▼ button to move the red arrow pointer to Video and then press the SELECT button. The Source Select Menu will appear.
- 3 Move the pointer to the source that you want to select and then press the SELECT button.

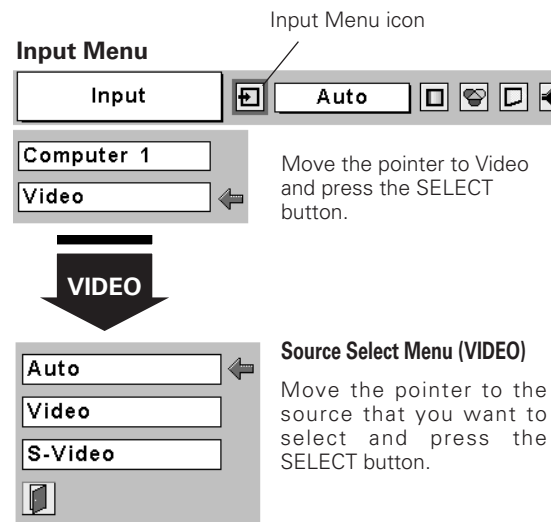

#### Auto

When selecting Auto, the projector automatically detects incoming video signal, and adjusts itself to optimize its performance. The projector selects connection in the following order:

- 1st S-Video
- 2nd Video

The S-VIDEO jack has priority over the VIDEO jack under the condition of connecting both the S-VIDEO jack and the VIDEO jack.

#### Video

When video input signal is connected to the VIDEO jack, select Video.

#### S-Video

When video input signal is connected to the S-VIDEO jack, select S-Video.

#### ✓ Note:

When Monitor out is selected at the Terminal item in the Setting Menu, Computer 2 is not displayed. (p44)

## Input Source Selection (Component, RGB Scart 21-Pin)

### Direct Operation

Choose Computer 2 by pressing the INPUT button on the top control or press the COMPUTER button on the remote control. Before using these buttons, correct input source should be selected through menu operation as described below.

#### INPUT button

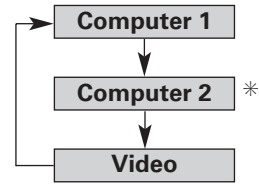

#### COMPUTER button

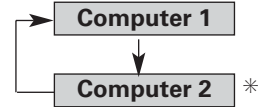

\* See Note on the bottom of this page.

### Menu Operation

- 1 Press the MENU button and the On-Screen Menu will appear. Press the Point ◀▶ button to move the red frame pointer to the Input Menu icon.
- 2 Press the Point ▼ button to move the red arrow pointer to Computer 2, and then press the SELECT button. The Source Select Menu will appear.
- 3 Move the pointer to the correct input source and then press the SELECT button.

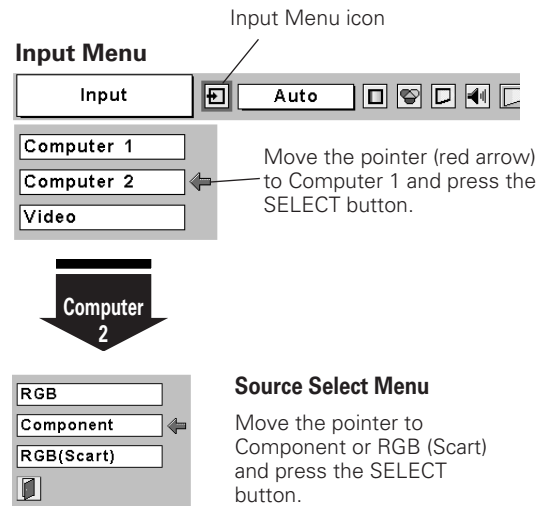

**Component** When the input source is coming from video equipment connected to the COMPUTER IN 2/ COMPONENT IN/ MONITOR OUT terminal with a Component-VGA Cable, select Component.

**RGB (Scart)** When the input source is coming from video equipment connected to the COMPUTER IN 2/ COMPONENT IN/ MONITOR OUT terminal with a Scart-VGA Cable, select RGB (Scart).

- ✓ **Note:**
- Component-VGA Cable and Scart-VGA Cable are optionally supplied. See page 61 for order.
  - Computer 2 is not displayed when the COMPUTER IN 2/COMPONENT IN/ MONITOR OUT terminal is set as Monitor out. (p44)

## Video System Selection

- 1 Press the MENU button and the On-Screen Menu will appear. Press the Point ◀▶ button to move the red frame pointer to the AV System Menu icon.
- 2 Press the Point ▼ button to move the red arrow pointer to the system that you want to select and then press the SELECT button.

### Video or S-Video

#### Auto

The projector automatically detects incoming video system, and adjusts itself to optimize its performance. When Video System is PAL-M or PAL-N, select system manually.

#### **PAL / SECAM / NTSC / NTSC4.43 / PAL-M / PAL-N**

If the projector cannot reproduce proper video image, it is necessary to select a specific broadcast signal format among PAL, SECAM, NTSC, NTSC 4.43, PAL-M, and PAL-N.

#### AV System Menu (Video or S-Video)

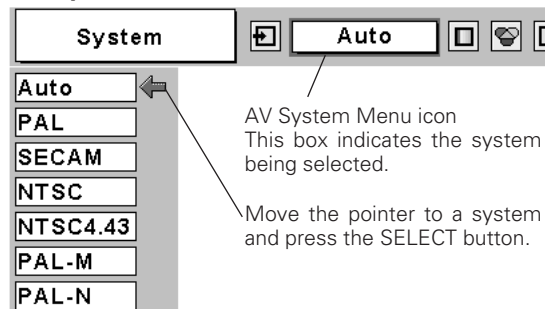

### Component

#### Auto

The projector automatically detects incoming video signal, and adjusts itself to optimize its performance.

#### **COMPONENT VIDEO SIGNAL FORMAT**

If the projector cannot reproduce proper video image, it is necessary to select a specific component video signal format among 480i, 575i, 480p, 575p, 720p, 1035i, and 1080i.

#### AV System Menu (Component)

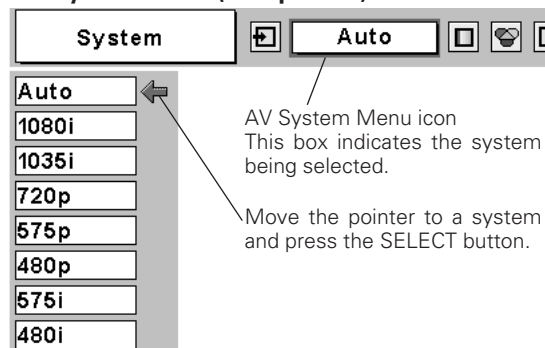

#### ✓ Note:

The AV System Menu cannot be selected when selecting RGB(Scart).

## Image Level Selection

### Direct Operation

Select a desired image level among Dynamic, Standard, Cinema, Blackboard (Green), Image 1, Image 2, Image 3, and Image 4 by pressing the IMAGE button on the remote control.

#### Dynamic

Picture level suitable for viewing picture in a bright room.

#### Standard

Normal picture level preset on this projector.

#### Cinema

Picture level adjusted for the picture with fine tone.

#### Blackboard(Green)

Picture level suitable for the image projected on a blackboard (Green).

This mode assists to enhance the image projected on a blackboard. This is mainly effective on a green colored board, not truly effective on a black colored board.

#### Image 1~4

User preset image in the Image Adjust Menu (p39, 40).

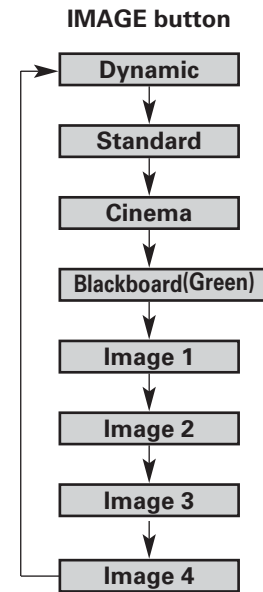

### Menu Operation

- 1 Press the MENU button and the On-Screen Menu will appear. Press the Point ◀▶ button to move the red frame pointer to the Image Select Menu icon.
- 2 Press the Point ▼ button to move the red frame pointer to the level that you want to set and then press the SELECT button.

#### **Dynamic**

Picture level suitable for viewing picture in a bright room.

#### **Standard**

Normal picture level preset on this projector.

#### **Cinema**

Picture level adjusted for the picture with fine tone.

#### **Blackboard(Green)**

Picture level suitable for the image projected on a Blackboard (Green). See above for further description.

#### **Image1~4**

User preset image in the Image Adjust Menu (p39, 40).

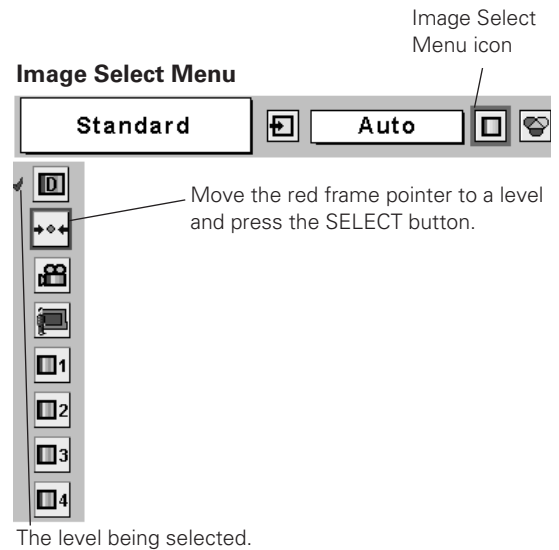

## Image Level Adjustment

- 1 Press the MENU button and the On-Screen Menu will appear. Press the Point ◀▶ button to move the red frame pointer to the Image Adjust Menu icon.
- 2 Press the Point ▼ button to move the red frame pointer to the item that you want to adjust and then press the SELECT button. The level of each item is displayed. Adjust each level by pressing the Point ◀▶ button.

### Contrast

Press the Point ◀ button to decrease contrast and the Point ▶ button to increase contrast. (From 0 to 63.)

### Brightness

Press the Point ◀ button to adjust image darker and the Point ▶ button to adjust image brighter. (From 0 to 63.)

### Color

Press the Point ◀ button to lighten color and the Point ▶ button to deepen color. (From 0 to 63.)

### Tint

Press the Point ◀▶ button to obtain proper color. (From 0 to 63.)

### Color temp.

Press the Point ◀▶ button for Color temp. level that you want to select. (XLow, Low, Mid, or High)

### White balance (Red)

Press the Point ◀ button to lighten red tone and the Point ▶ button to deepen red tone. (From 0 to 63.)

### White balance (Green)

Press the Point ◀ button to lighten green tone and the Point ▶ button to deepen green tone. (From 0 to 63.)

### White balance (Blue)

Press the Point ◀ button to lighten blue tone and the Point ▶ button to deepen blue tone. (From 0 to 63.)

### Sharpness

Press the Point ◀ button to soften the image and the Point ▶ button to sharpen the image. (From 0 to 15.)

### Gamma

Press the Point ◀▶ button to obtain better balance of contrast. (From 0 to 15.)

### Image Adjust Menu

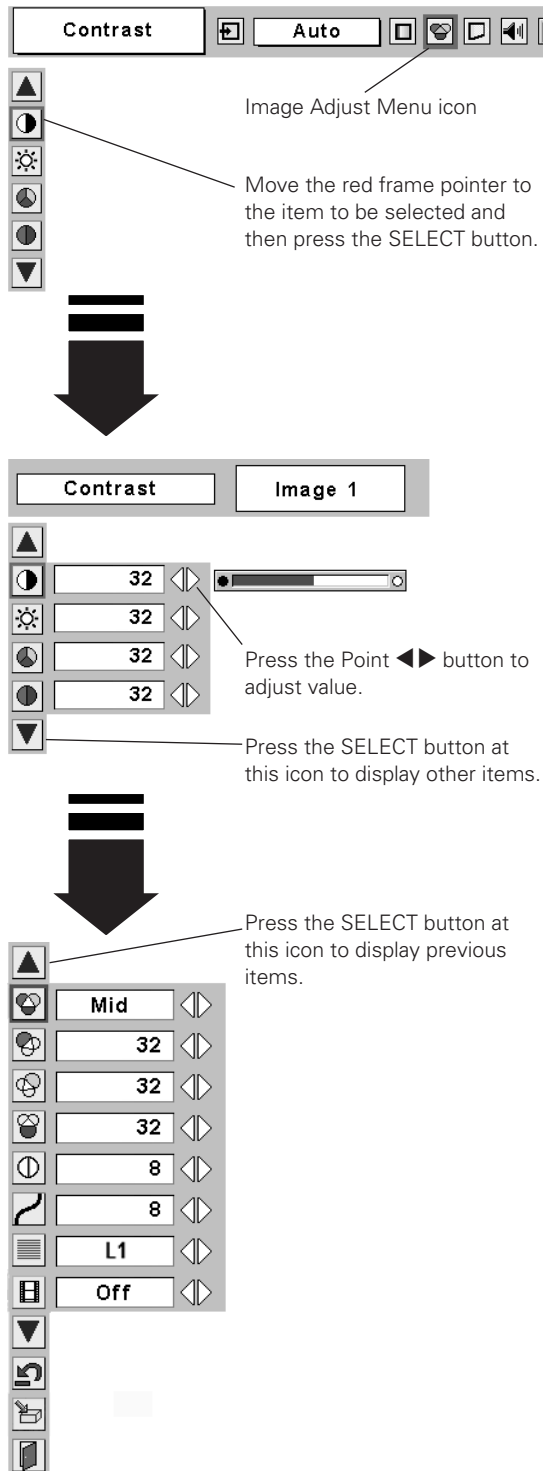

✓ **Note:**

The Tint cannot be adjusted when the video system is PAL, SECAM, PAL-M, or PAL-N.



## Screen Size Adjustment

This projector has a picture screen resize function, which enables you to display the desirable image size.

- 1 Press the MENU button and the On-Screen Menu will appear. Press the Point ◀▶ button to move the red frame pointer to the Screen Menu icon.
- 2 Press the Point ▼ button and move the red frame pointer to the function that you want to select and then press the SELECT button.

### **Normal**

Provides image at a normal video aspect ratio of 4 : 3.

### **Wide**

Provides image at a wide screen ratio of 16 : 9.

#### ✓ **Note:**

Screen Menu cannot be operated when "720p", "1035i", or "1080i" is selected in the AV System Menu (p37).

### Screen Menu

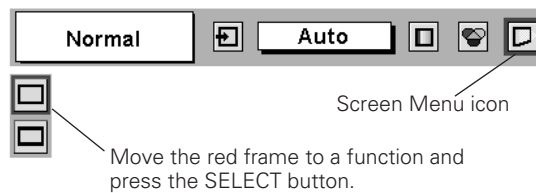

## Setting

This projector has Setting menu that allows you to set up the other various functions described as follows;

- 1 Press the MENU button to display the On-Screen Menu. Press the Point ◀▶ button to move the red frame pointer to the Setting Menu icon.
- 2 Press the Point ▼ button to move the red frame pointer to the item that you want to set and then press the SELECT button. The Setting dialog box appears.

### Language

The language used in the On-Screen Menu is available in English, German, French, Italian, Spanish, Portuguese, Dutch, Swedish, Russian, Chinese, Korean, or Japanese.

### Auto Setup

This function enables Auto Keystone correction and Auto PC adjustment by pressing the AUTO SETUP button on the top control or the AUTO SET button on the remote control. Settings for those functions can be altered as follows:

#### Auto PC Adj.

- On . . . . .enables Auto PC Adjustment when pressing the AUTO SET button on the remote control or the AUTO SETUP button on the top control.
- Off . . . . .disables Auto PC Adjustment.

#### Auto Keystone

- Auto . . . . . always works and corrects keystone distortion according to the projector's tilt.
- Manual . . . . .works only when pressing the AUTO SET button on the remote control or the AUTO SETUP button on the top control.
- Off . . . . .disables Auto Keystone.

#### ✓ Note:

- Auto PC Adj. and Auto Keystone cannot be set "Off" at the same time.
- Auto Keystone corrects vertical distortion only, not correct horizontal distortion.
- The Auto Keystone cannot work when Ceiling feature is On in the Setting menu. (p44)
- Perfect correction of the image distortion cannot be ensured with the Auto Setup function. If the distortion is not corrected properly by pressing the AUTO SETUP/ AUTO SET button, adjust manually by pressing the KEYSTONE button on the remote control or selecting Keystone in the Setting menu. (See p25 or Keystone feature below.)

### Keystone

This function corrects distortion of a projected image. Select either Store or Reset with the Point ◀▶ button, and then press the Select button. The keystone dialog box appears. Adjust keystone with the Point ▲▼ button.

- Store . . . . . stores the keystone adjustment even if the AC power cord is disconnected.
- Reset . . . . .resets the keystone adjustment when the AC power cord is disconnected.

### Setting Menu (Language)

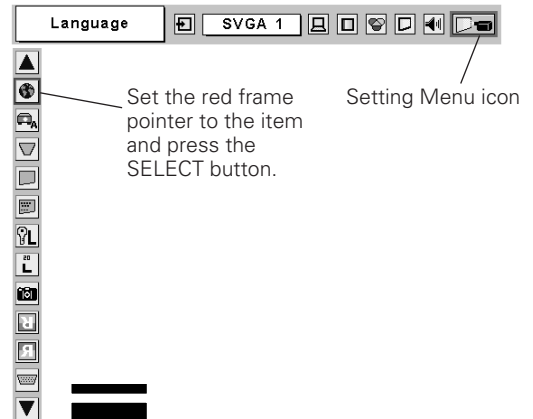

When pressing the SELECT button at Language, the Language Menu appears.

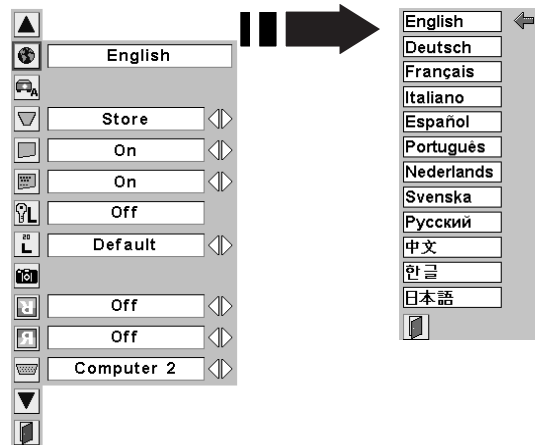

### Auto Setup

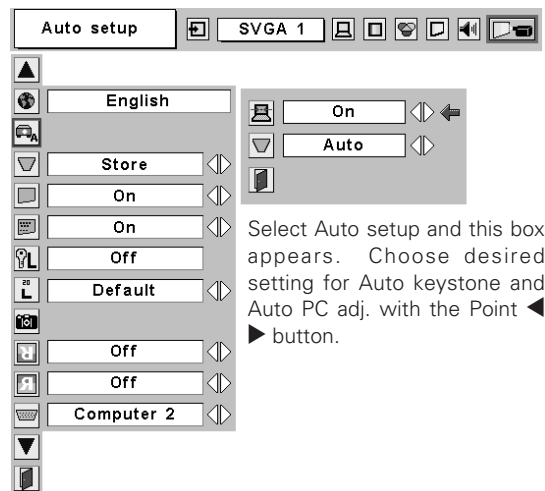

 **Blue back**

When this function is "On," the projector produces a blue image while input signal is not detected.

 **Display**

This function decides whether to display On-Screen Displays.

- On . . . . . shows all the On-Screen Displays.
- Off . . . . . does not show On-Screen Displays except;

- On-Screen Menu
- "Power off?" message
- P-Timer
- "No signal" message
- "Wait a moment!" message

 **Logo PIN Code Lock**

This function prevents an unauthorized person from changing the Logo setting.

- Off . . . . .the Logo setting can be changed freely from the Logo menu. (p44)
- On . . . . .the Logo setting cannot be changed without the Logo PIN code.

If you want to change the Logo PIN Code Lock setting, enter a Logo PIN code along the following steps. The initial Logo PIN code is set "4321" at the factory.

**Enter a Logo PIN code**

Select a number by pressing the Point ◀▶ button and fix the number with the SELECT button. The number will change to "\*". If you fixed a wrong number, move the pointer to "Set" or "Clear" once by pressing the Point ▼ button, then return to "Logo PIN code". Enter the correct number again.

Repeat this step to complete entering a four-digit number.

When the four-digit number is fixed, the pointer will automatically move to "Set". Press the SELECT button so that you can change the Logo PIN code lock setting.

If you entered a wrong Logo PIN code, "Logo PIN code" and the number (\*\*\*\*) will turn red and disappear. Enter a correct Logo PIN code all over again.

**Change the Logo PIN code**

Logo PIN code can be changed to your desired four-digit number. Select "Logo PIN code change" with the Point ▼ button and press the SELECT button. Set a new Logo PIN code.

Be sure to note the new Logo PIN code and keep it at hand. If you lost the number, you could no longer change the Logo PIN code setting. For details on PIN code setting, refer to relevant instructions of the PIN Code Lock function on page 47.

**Logo PIN Code Lock**

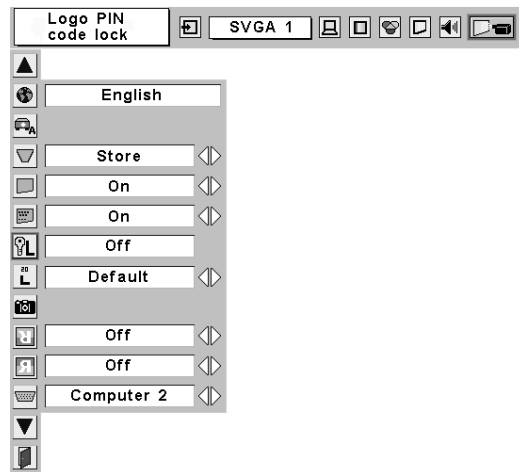

**Logo PIN Code Lock Dialog Box**

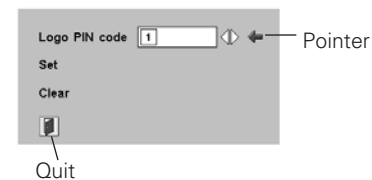

After a correct Logo PIN code is entered, the following dialog box will appear.

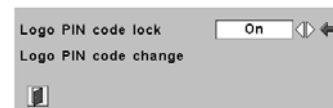

Select On/OFF by pressing the Point ◀▶ button or change the Logo PIN code.

**Logo**

This function decides what to be displayed on the starting-up display as follows:

- User . . . . .the image you captured
- Default . . . .the factory-set logo
- Off . . . . .count-down only

**Capture**

This function enables you to capture the image being projected and use it for a starting-up display or interval of presentations.

After capturing the projected image, go to the Logo function and set it to "User". Then the captured image can be displayed when turning on the projector next time or pressing the NO SHOW button. (p25)

To capture the image, select [Yes]. To cancel the Capture function, select [No].

**Note:**

- Before capturing an image, select Standard in the Image Select Menu to capture a proper image. (See page 32, 38.)
- A signal from a computer can be captured up to XGA(1024 x 768). A signal from video equipment can be captured except for 720p, 1035i, and 1080i.
- When capturing the image that has been adjusted by the Keystone function, the adjustment data is automatically reset and the projector captures an image without keystone adjustment.
- When the Logo PIN code lock function is On, the Logo and Capture menu cannot be selected.

**Ceiling**

When this function is "On," the picture is top/bottom and left/right reversed. This function is used to project the image from a ceiling mounting the projector.

**Rear**

When this function is "On," the picture is left/right reversed. This function is used to project the image to a rear projection screen.

**Terminal**

The COMPUTER IN 2/COMPONENT IN/MONITOR OUT terminal on the back of the projector is switchable for computer input or monitor output. (See page 9) Select Computer 2 or Monitor Out with the Point ◀▶ button.

- Computer 2 . . . . .computer input
- Monitor Out . . . . .monitor out

Terminal item is not available when selecting Computer 2 to the input source. Change the input source to the others (Computer1 or Video) so that the Terminal item will be available. (p27, 35, 36)

**Capture**

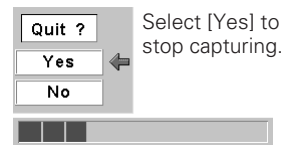
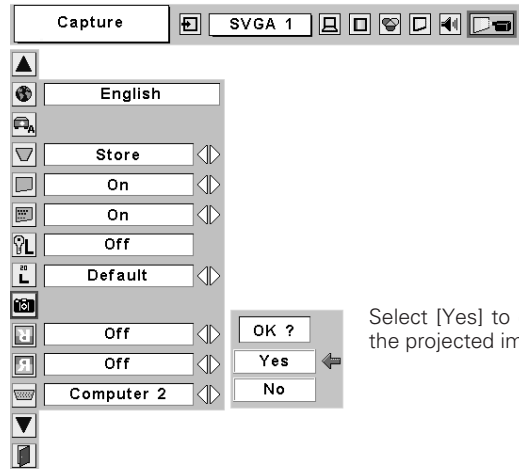

**Ceiling**

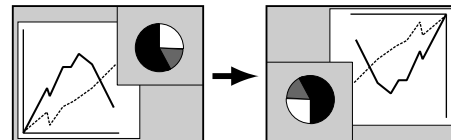

**Rear**

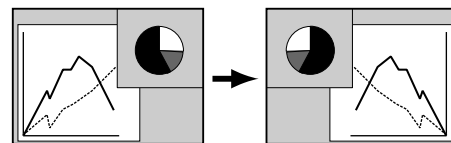

 **Standby mode**

This function is available when using Multi Card Imager optionally supplied, and it reduces standby energy when selecting Eco.

Eco ..... reduces standby energy.

Normal ..... consumes normal standby energy.

 **Power management**

For reducing power consumption as well as maintaining the lamp life, the Power Management function turns off the projection lamp when the input signal is interrupted and no button is pressed for 30 seconds or more.

If the input signal is interrupted and no button is pressed for 30 seconds or more, the timer display with the message "No signal" appears on the screen. The count-down of the set time will get started. The count-down time can be set between 1 and 30 minutes.

When the count-down time has been elapsed, the lamp will be turned off to cool itself down. The POWER indicator is blinking red during this cooling-off period. The next operation depends on the setting as follows :

Ready . . . . .When the lamp has been fully cooled down, the POWER indicator changes to green blinking. In this condition, the projection lamp will be turned on if the input signal is reconnected or any button on the top control or remote control unit is pressed.

Shutdown . . .When the lamp has been fully cooled down, the power will be turned off.

Off . . . . .The Power Management function is canceled.

 **On start**

When this function is "On," the projector is automatically turned on just by connecting the AC power cord to a wall outlet.

 **Note:**

Be sure to turn the projector off properly (see "Turning Off the Projector" on page 21). If the projector is turned off in the wrong steps, the On start function does not operate properly.

 **Lamp mode**

This function allows you to change brightness of the screen.

 ..... normal brightness

 ..... brightness according with the input signal

 ..... lower brightness reduces the lamp power consumption and extends the lamp life.

**Standby mode**

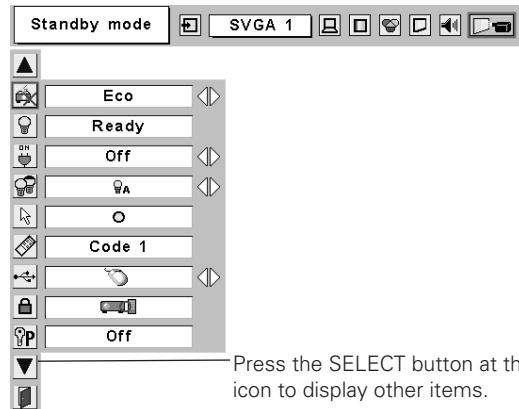

**Power management**

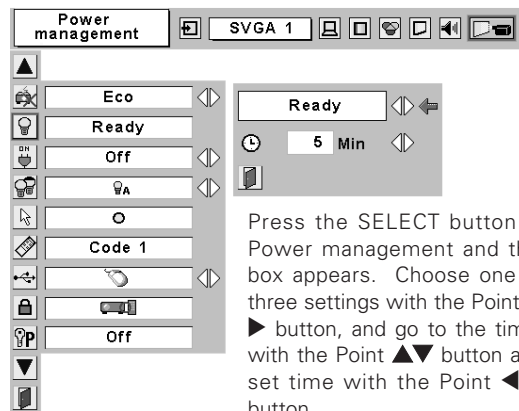

 **Pointer**

You can emphasize a part of the projected image with this function. Choose either Spotlight or Pointer with the Point ▲▼ button and press the SELECT button. Then select one of three different sizes (Large, Middle, and Small) of Spotlight or a pointer of three different patterns (Arrow, Finger, and Dot) of Pointer. (See page 12 for operation.)

 **Remote control**

This projector provides eight different remote control codes (Code 1-Code 8); the factory-set, initial code (Code 1) and the other seven codes (Code 2 to Code 8). This switching function prevents remote control interference when operating several projectors or video equipment at the same time. For example operating the projector in "Code 7", both the projector and the remote control must be switched to "Code 7".

**To change the code for the projector:**



Select a remote control code in this Setting Menu.

**To change the code for the remote control:**

While holding down the MENU button, press the IMAGE button number of times corresponding to the remote control code for the projector. (See page 14 for details.)



 **USB**

This projector is equipped with the USB port for interactive operation between the projector and computer. Selects either of the followings as needed.

-  .... When using the remote control as the wireless mouse for a computer connected to the projector with a USB cable. (p13, 17)
-  .... When controlling the projector with a computer. This item is provided for future use. Unavailable now.

 **Key lock**

This function locks operation of the top control and remote control. It is useful to prevent operation by an unauthorized person.

-  .... not locked.
-  .... locks operation of the top control. To unlock, use the remote control.
-  .... locks operation of the remote control. To unlock, use the top control.

If the top control accidentally becomes locked and you do not have the remote control nearby, disconnect the AC power cord from the AC outlet, and then with pressing the SELECT button, reinsert the AC power cord. This will cancel the top control lock.

**Pointer**

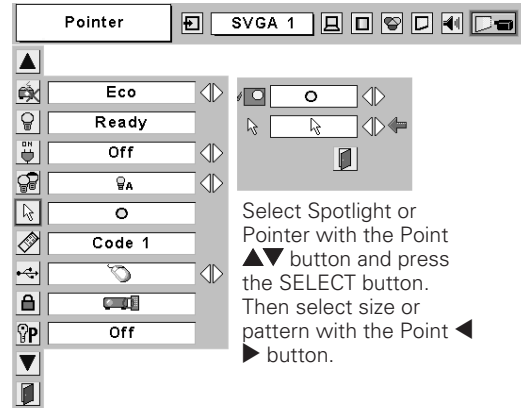

**Remote control**

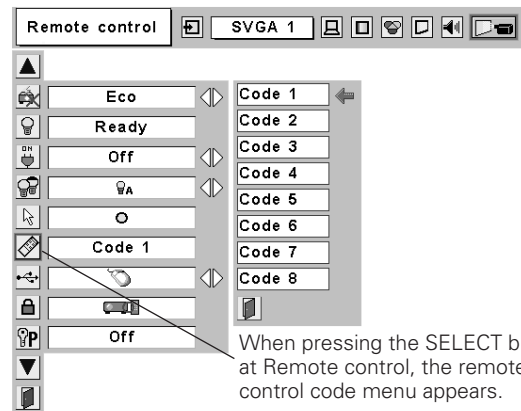

**Key lock**

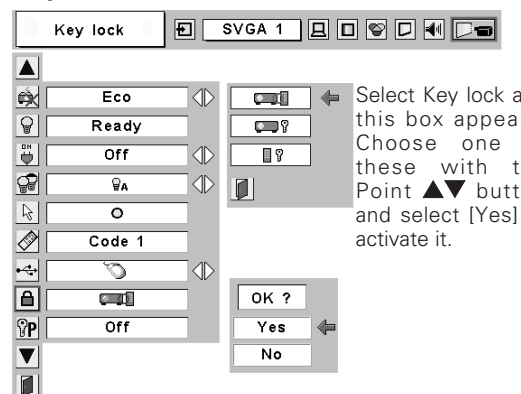

**PIN code lock**

This function prevents the projector from being operated by an unauthorized person and provides the following settings for security options.

- Off.....the projector is unlocked with the PIN code.
- On1 .....requires to enter the PIN code every time turning on the projector.
- On2.....requires to enter the PIN code to operate the projector once the power cord is disconnected; as long as the AC power cord is connected, the projector can be operated without the PIN code.

Whenever to change the PIN Code Lock setting or the PIN code (the four-digit number), you are required to enter the PIN code. "1234" is set as the initial PIN code at the factory.

**Enter a PIN code**

Select a number by pressing the Point ◀▶ button and fix the number with the SELECT button. The number will change to "\*". If you fixed a wrong number, move the pointer to "Set" or "Clear" once by pressing the Point ▼ button, then return to "PIN code". Enter the correct number again. Repeat this step to complete entering a four-digit number.

When the four-digit number is fixed, the pointer will automatically move to "Set". Press the SELECT button so that you can change the following PIN code lock settings.

If you entered a wrong PIN code, "PIN code" and the number (\*\*\*) will turn red and disappear. Enter a correct PIN code all over again.

**To Change the PIN Code Lock setting**

Select Off, On1, or On2 with the Point ◀▶ button and then "Quit" with the Point ▼ button and press the SELECT button to close the dialog box.

**To Change the PIN Code**

The PIN code can be changed to your desired four-digit number. Select "PIN code change" with the Point ▼ button, and press the SELECT button. The New PIN code input dialog box will appear.

Select a number with the Point ◀▶ button and fix the number with the SELECT button. Repeat it to complete entering a four-digit number. When the four-digit number is fixed, the pointer will automatically move to "Set". Then press the SELECT button.

**CAUTION:**  
**WHEN YOU HAVE CHANGED PIN CODE, WRITE DOWN THE NEW PIN CODE IN COLUMN OF THE PIN CODE NO. MEMO ON PAGE 63, AND KEEP IT SECURELY. SHOULD THE PIN CODE BE LOST OR FORGOTTEN, THE PROJECTOR CAN NO LONGER BE OPERATED.**

**PIN code lock**

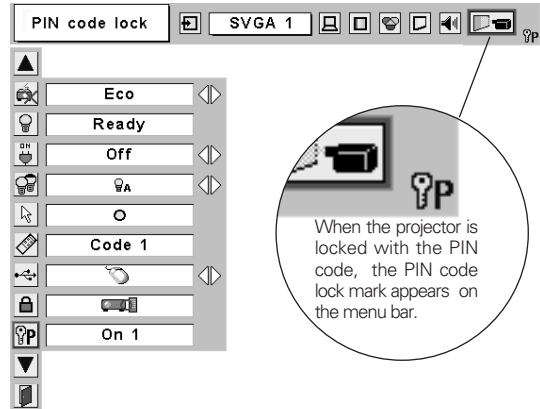

**Enter a PIN code**

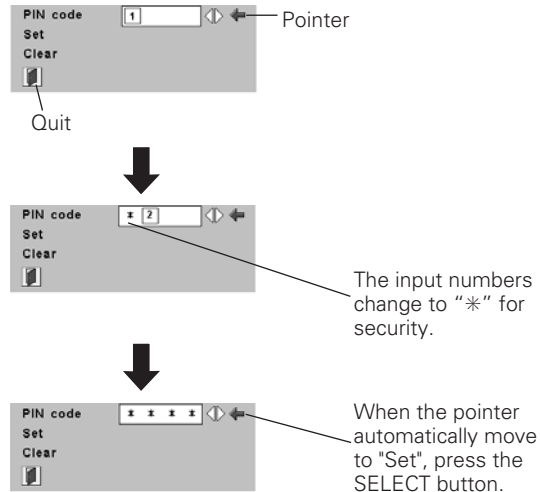

**Change the PIN Code Lock setting**



**Change the PIN code**

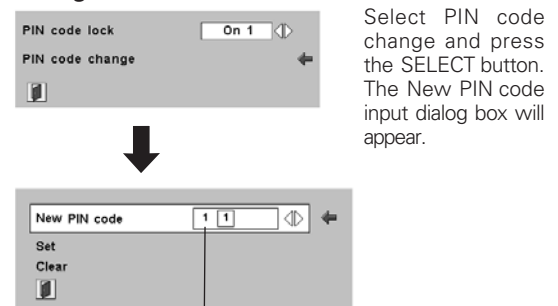

 **Fan**

This function provides you the following alternatives in the cooling fans operation after turning off the projector. (p21)

- L1 . . . . .normal operation
- L2 . . . . .slower operation than the normal (L1) , but takes longer to cool down the projector. In this mode, cooling time after turning off the projector will be extended longer than in the normal mode.

 **Lamp counter reset**

This function is used to reset the lamp replace counter. When replacing the projection lamp, reset the lamp replace counter by using this function. See page 53 for operation.

 **Factory default**

This function returns all setting values except for the user logo, PIN code lock, logo PIN code lock and the lamp counter to the factory default settings.

**Fan**

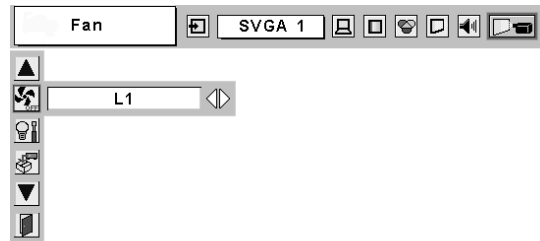

**Factory default**

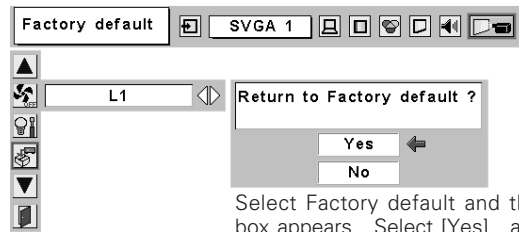

Select Factory default and this box appears. Select [Yes] , and the next box appears.



## Warning Indicator

The WARNING indicator shows the state of the function which protects the projector. Check the state of the WARNING indicator and the POWER indicator to take proper maintenance.

### The projector is shut down and the WARNING indicator is blinking red.

When the temperature inside the projector exceeds the normal temperature, the projector is automatically shut down to protect the inside of the projector. The POWER indicator is blinking and the projector is being cooled down. When the temperature inside the projector returns to normal, the POWER indicator lights red and the projector can be turned on.

✓ **Note:**

After the temperature inside the projector returns to normal, the WARNING indicator still continues to blink. When the projector is turned on again, the WARNING indicator stops blinking.

### TOP CONTROL

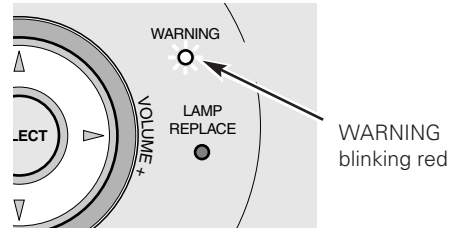

### Then check the matters below:

- Did you provide appropriate space for the projector to be ventilated? Check the installing condition to see if ventilation slots are not blocked.
- Is the projector not installed near the ventilation duct of air-conditioning equipment which may be hot? Install the projector away from the ventilation duct of air-conditioning equipment.
- Are the air filters clean? Clean the air filters periodically. (p50)

### The projector is shut down and the WARNING indicator lights red.

When the projector detects an abnormal condition, it is automatically shut down to protect the inside and the WARNING indicator lights red. In this case, disconnect the AC power cord and reconnect it, and then turn the projector on once again for check. If the projector is still turned off and the WARNING indicator lights red, disconnect the AC power cord and contact the service station for check and repair.

### TOP CONTROL

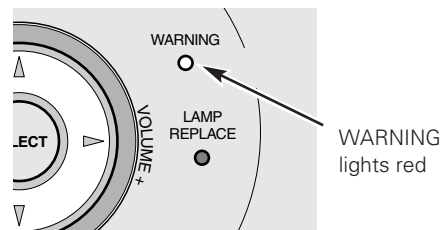

### **CAUTION**

DO NOT LEAVE THE PROJECTOR WITH THE AC POWER CORD CONNECTED UNDER THE ABNORMAL CONDITION. IT MAY RESULT IN FIRE OR ELECTRIC SHOCK.

### Cleaning the Air Filters

Air filters prevent dust from accumulating on the surface of the optical elements inside the projector. Should the air filters become clogged with dust particles, it will reduce cooling fans' effectiveness and may result in internal heat build up and adversely affect the life of the projector. Clean the air filters following the steps below.

- 1 Turn off the projector, and disconnect the AC power cord from the AC outlet.
- 2 Turn the projector upside down and remove the air filters by pulling the latches upward.
- 3 Clean the air filters with a brush or rinse them softly. Clean the ventillation slots around the air filter too.
- 4 When cleaning the air filters by rinsing, dry them well. Replace the air filters properly. Make sure that the air filters are fully inserted.



#### **CAUTION**

Do not operate the projector with the air filters removed. Dust may accumulate on the LCD panel and the projection mirror degrading picture quality. Do not put small parts into the air intake vents. It may result in malfunction of the projector.

#### **RECOMMENDATION**

**We recommend avoiding dusty/smoky environments when operating the projector. Usage in these environments may cause poor image quality.**

When using the projector under dusty or smoky conditions, dust may accumulate on a lens, LCD panels, or optical elements inside the projector. This condition may degrade the quality of a projected image.

When the symptoms above are noticed, contact your authorized dealer or service station for proper cleaning.

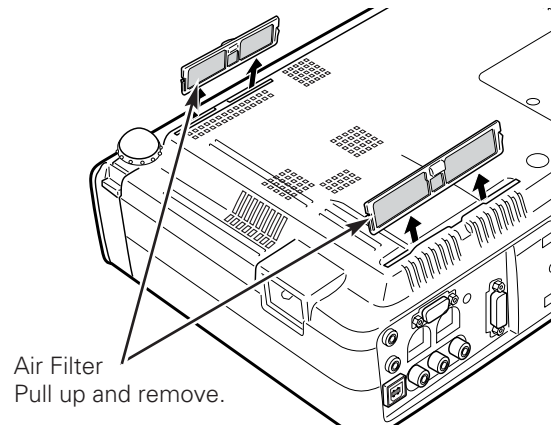

### Attaching the Lens Cover

When moving this projector or while not using it over an extended period of time, replace the lens cover.

- 1 Pass the string through a hole of the lens cover.
- 2 Turn the projector upside down.
- 3 Attach the string with lens cover to a hole on the bottom of the projector and secure it with a screw.

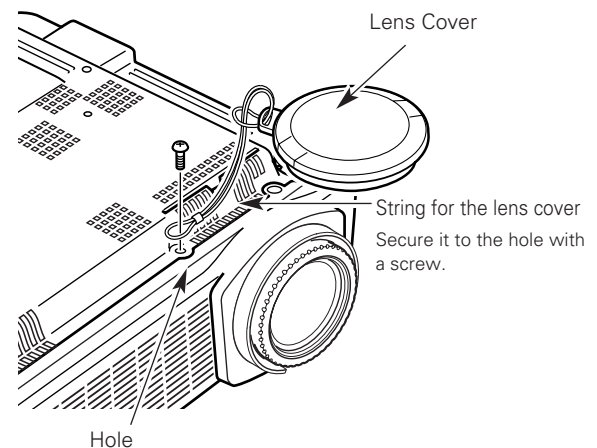

## Cleaning the Projection Lens

Follow these steps to clean the projection lens.

- 1** Disconnect the AC power cord before cleaning.
- 2** Softly wipe the projection lens with a cleaning cloth that contains a small amount of non-abrasive camera lens cleaner, or use lens cleaning paper or a commercially available air blower to clean the lens. Avoid using an excessive amount of cleaner. Abrasive cleaners, solvents, or other harsh chemicals might scratch the surface.
- 3** When the projector is not in use, replace the lens cover.

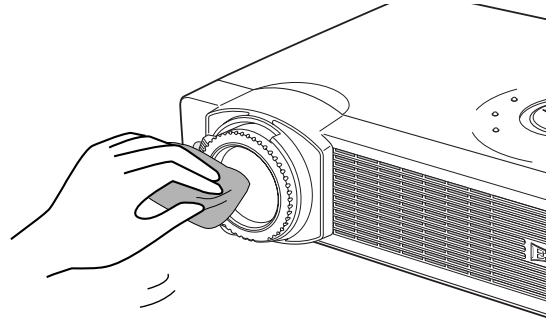

## Cleaning the Projector Cabinet

Follow these steps to clean the projector cabinet.

- 1** Disconnect the AC power cord before cleaning.
- 2** Softly wipe the projector body with a soft, dry cleaning cloth. When it is heavily soiled, use a small amount of mild detergent and finish with a soft, dry cleaning cloth. Avoid using an excessive amount of cleaner. Abrasive cleaners, solvents, or other harsh chemicals might scratch the surface.
- 3** When the projector is not in use, put the projector in an appropriate carrying case to protect it from dust and scratches.

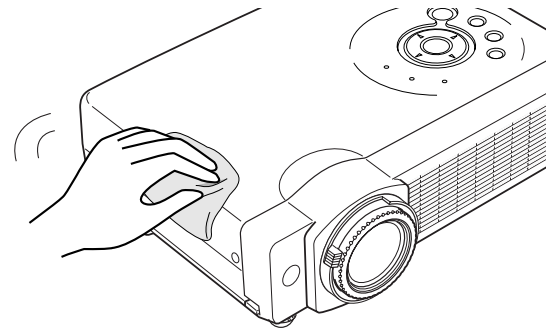

## Lamp Replacement

When the life of the projection lamp of this projector draws to an end, the LAMP REPLACE indicator lights yellow. If this indicator lights yellow, replace the lamp with a new one promptly.

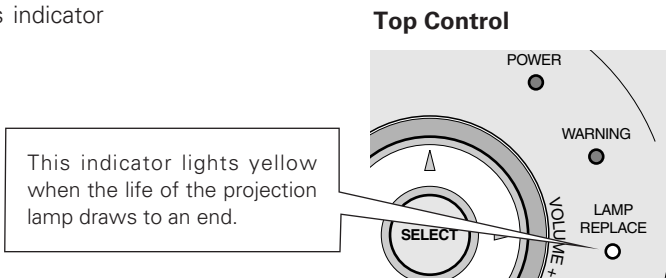

### CAUTION

Allow a projector to cool, for at least 45 minutes before you open the Lamp cover. The inside of the projector can become very hot.



### CAUTION

For continued safety, replace with a lamp of the same type. Do not drop a lamp or touch a glass bulb! The glass can shatter and may cause injury.

Follow these steps to replace the lamp.

- 1** Turn off the projector and disconnect the AC plug. Allow the projector to cool for at least 45 minutes.
- 2** Loosen the screw with a screwdriver, and remove the lamp cover.
- 3** Loosen 2 screws of the lamp with a screwdriver and pull out the lamp by grasping the handle.
- 4** Replace the lamp with a new one and tighten the 2 screws back into position. Make sure that the lamp is set properly. Replace the lamp cover and tighten the screw.
- 5** Connect the AC power cord to the projector and turn on the projector.
- 6** **Reset the Lamp replace counter.**  
See "Lamp Replace Counter" on the next page .

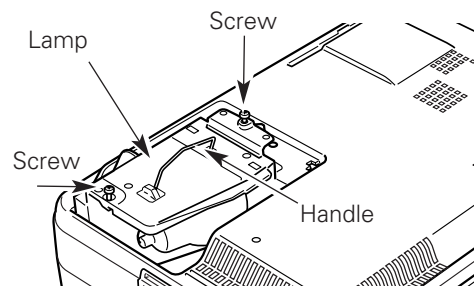
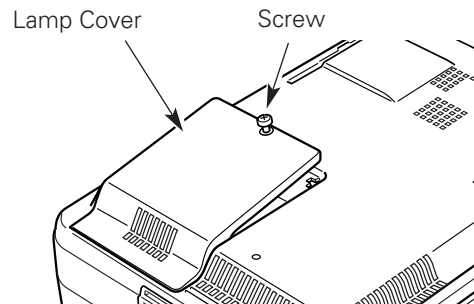

### **ORDER REPLACEMENT LAMP**

Replacement lamp can be ordered through your dealer. When ordering a projection lamp, give the following information to the dealer.

- **Model No. of your projector** : **LC-XB26/ LC-XB21**
- **Replacement Lamp Type No.** : **POA-LMP65 (for LC-XB26)**  
(Service Parts No. 610 307 7925)  
**POA-LMP55 (for LC-XB21)**  
(Service Parts No. 610 309 2706)

## Lamp Replace Counter

Be sure to reset the lamp replace counter after the lamp is replaced. When the lamp replace counter is reset, the LAMP REPLACE indicator stops lighting.

- 1 Turn the projector on, press the MENU button and the On-Screen Menu will appear. Press the Point ◀▶ button to move the red frame pointer to the Setting Menu icon.
- 2 Press the Point ▼ button to move the red frame pointer to the Lamp counter reset item and then press the SELECT button. The message "Lamp replace counter Reset?" is displayed. Move the pointer to [Yes] and then press the SELECT button.
- 3 Another confirmation dialog box appears and select [Yes] to reset the Lamp replace counter.

### ✓ Note:

Do not reset the Lamp replace counter without implementation of lamp replacement. Be sure to reset the Lamp replace counter only after replacing the lamp.

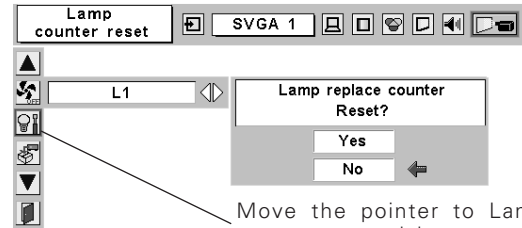

Move the pointer to Lamp counter reset and then press the SELECT button. The message "Lamp replace counter Reset?" is displayed.



## LAMP HANDLING PRECAUTIONS

This projector uses a high-pressure lamp which must be handled carefully and properly. Improper handling may result in accidents, injury, or create a fire hazard.

- Lamp life may differ from lamp to lamp and according to the environment of use. There is no guarantee of the same life for each lamp. Some lamps may fail or terminate their life in a shorter period of time than other similar lamps.
- If the projector indicates that the lamp should be replaced, i.e., if the LAMP REPLACE indicator lights up, replace the lamp with a new one IMMEDIATELY after the projector has cooled down. ( Follow carefully the instructions in the Lamp Replacement section of this manual. ) Continuous use of the lamp with the LAMP REPLACE indicator lighted may increase the risk of lamp explosion.
- A Lamp may explode as a result of vibration, shock or degradation as a result of hours of use as its lifetime draws to an end. Risk of explosion may differ according to the environment or conditions in which the projector and lamp are being used.

### IF A LAMP EXPLODES, THE FOLLOWING SAFETY PRECAUTIONS SHOULD BE TAKEN.

If a lamp explodes, disconnect the projector's AC plug from the AC outlet immediately. Contact an authorized service station for a checkup of the unit and replacement of the lamp. Additionally, check carefully to ensure that there are no broken shards or pieces of glass around the projector or coming out from the cooling air circulation holes. Any broken shards found should be cleaned up carefully. No one should check the inside of the projector except those who are authorized trained technicians and who are familiar with projector service. Inappropriate attempts to service the unit by anyone, especially those who are not appropriately trained to do so, may result in an accident or injury caused by pieces of broken glass.

## Troubleshooting

Before calling your dealer or service center for assistance, check the items below once again.

- Make sure you have properly connected the projector to peripheral equipment as described in "Connecting to a Computer" and "Connecting to Video Equipment" on page 17-19.
- Make sure all equipment is connected to AC outlet and the power is turned on.
- When you operate the projector with a computer and it does not project an image, restart the computer.

---

**Problem:**

– Solutions

---

**No power**

- Plug the power cord of the projector into the AC outlet.
  - See if the POWER indicator lights red.
  - Wait 90-120 seconds after the projector is turned OFF when turning the projector back on. The projector can be turned on after the POWER indicator turns red. (See "Turning Off the Projector" on page 21.)
  - Check the WARNING indicator. If the WARNING indicator lights red, the projector cannot be turned on. (See "Warning Indicator" on page 49.)
  - Check the projection lamp. (See page 52.)
  - Unlock Key lock for the projector in the Setting Menu. (See page 46.)
- 

**Image is out of focus.**

- Adjust focus of the projector. (See page 24.)
  - Provide proper distance between the projector and the projection screen. (See page 15.)
  - Check the projection lens to see if it needs cleaning. (See page 51.)
  - Moving the projector from a cool to a warm place may result in moisture condensation on the projection lens. In such cases, leave the projector OFF and wait until condensation disappears.
- 

**No image**

- Check the connection between your computer or video equipment and the projector. (See page 17–19)
  - See if the input signal is correctly output from your computer. Some laptop computers may need to change the setting for monitor output when connecting to a projector. See your computer's instruction manual for the setting.
  - It takes about 20 seconds to display an image after turning on the projector.
  - See if the selected system is corresponding with your computer or video equipment. (See page 28 and 37)
  - Select correct input source once again through menu operation. (See page 27, 35 and 36)
  - Make sure the temperature is not out of the specified Operating Temperature (5°C ~ 35°C).
- 

**Image is Left/Right reversed.  
Image is Top/Bottom reversed.**

- Check the Ceiling / Rear item. (See "Setting" on page 44.)
  - Check the Ceiling item. (See "Setting" on page 44.)
- 

**No sound**

- Check audio cable connection from audio input source.
  - Adjust the audio source.
  - Press the Volume (+) button. (See page 26.)
  - Press the Mute button. (See page 26.)
-

<b>Some displays are not seen during the Operation.</b>	– Check the Display item. (See “Setting” on page 43.)
<b>PIN code dialog box appears at start-up.</b>	– PIN code lock is being set. Input a PIN code (1234 or numbers you have set). (See “PIN code lock” on page 20 and 47.)
<b>Computer 2 cannot be selected.</b>	– Select Computer 2 at the Terminal item in the Setting Menu. (See “Setting” on page 44.)
<b>The Terminal item cannot be selected.</b>	– The Terminal item in the Setting Menu cannot be selected after Computer 2 is selected. Select other input source such as Computer 1 or Video with the INPUT button on the top control, the COMPUTER button or the VIDEO button on the remote control so that the Terminal item can be selected.
<b>The Remote Control does not work.</b>	<ul style="list-style-type: none"> <li>– Check the batteries.</li> <li>– Make sure no obstruction is between the projector and remote control.</li> <li>– Make sure you are not too far from the projector when using the remote control. Maximum operating range is 16.4’ (5m).</li> <li>– Make sure the code of the remote control is conformed to the projector. (See page 14 and 46.)</li> <li>– Unlock Key lock for the remote control in the Setting Menu. (See page 46.)</li> </ul>
<b>Wireless Mouse function does not work.</b>	<ul style="list-style-type: none"> <li>– Make sure your computer is connected to the projector with a USB cable. (See page 17.)</li> <li>– Check cable connection between the projector and your computer. (See page 17.)</li> </ul>

**WARNING :**

**High voltages are used to operate this projector. Do not attempt to open the cabinet.**

If problems still persist after following all operating instructions, contact the dealer where you purchased the projector or the service center. Give the model number and explain about the problem. We will advise you how to obtain service.



The CE Mark is a Directive conformity mark of the European Community (EC).



This symbol on the nameplate means the product is Listed by Underwriters Laboratories Inc. It is designed and manufactured to meet rigid U.L. safety standards against risk of fire, casualty and electrical hazards.

## Menu Tree

### Computer Input / Video Input

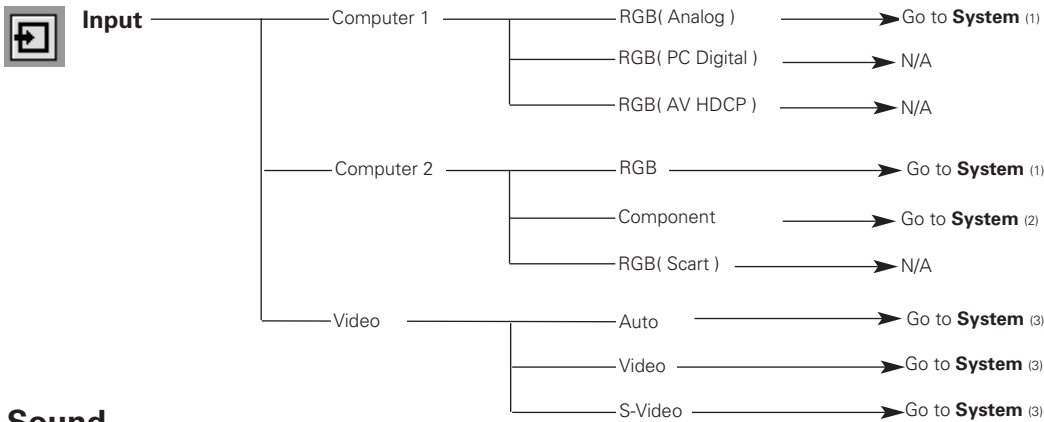

\*N/A --- not applicable

### Sound

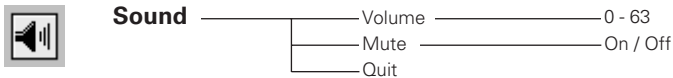

### Computer Input

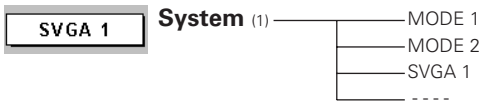

\*Systems displayed in the System Menu vary depending on an input signal.

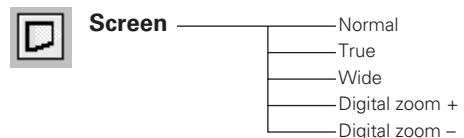
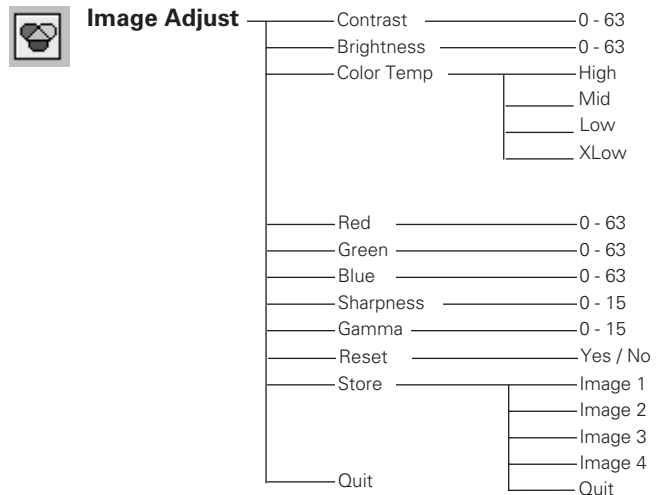
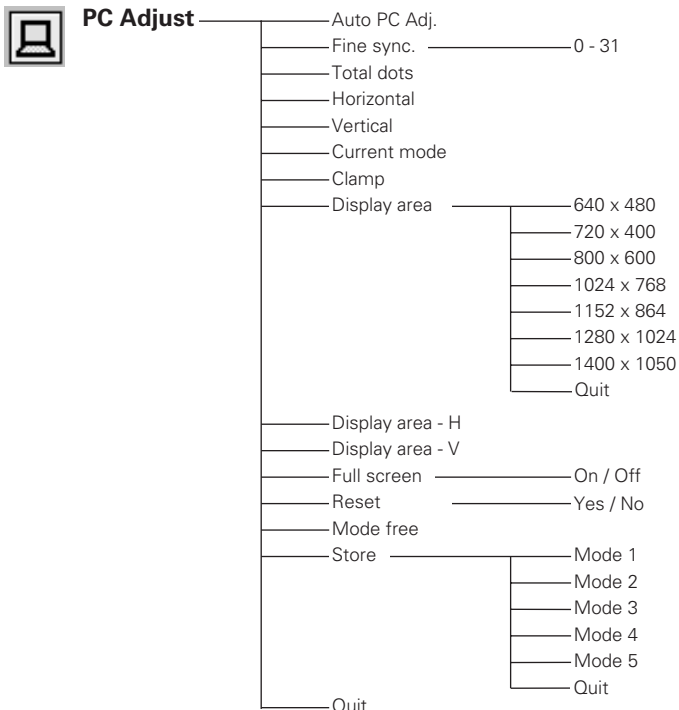
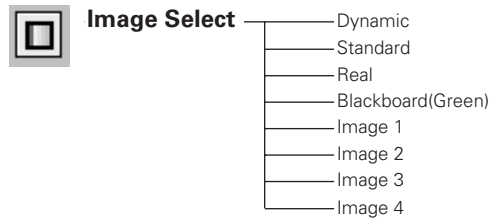

## Video Input

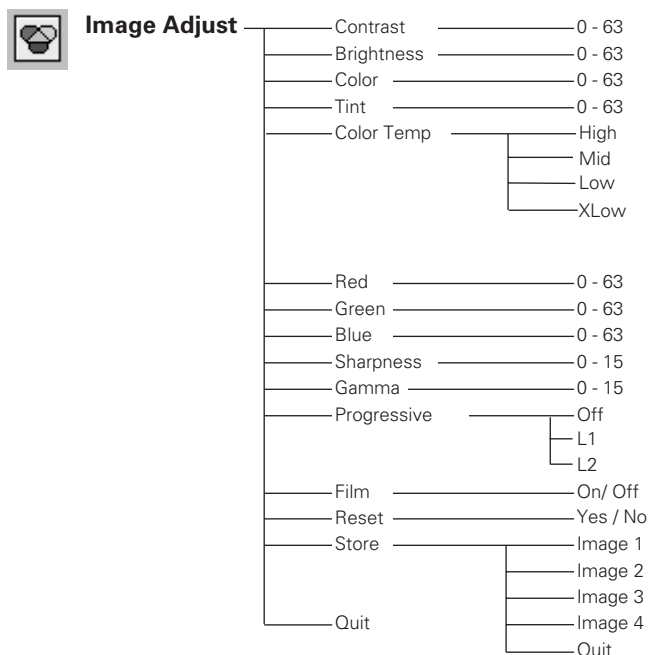
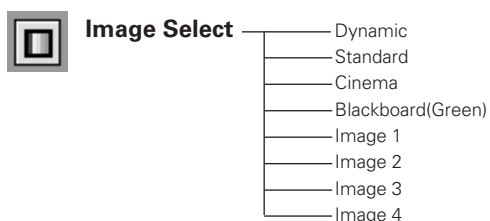
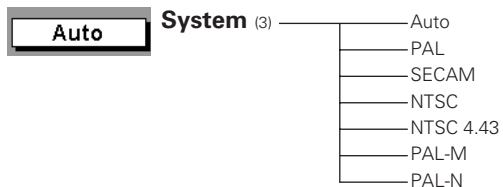
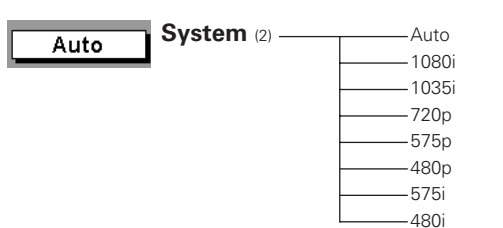

## Setting

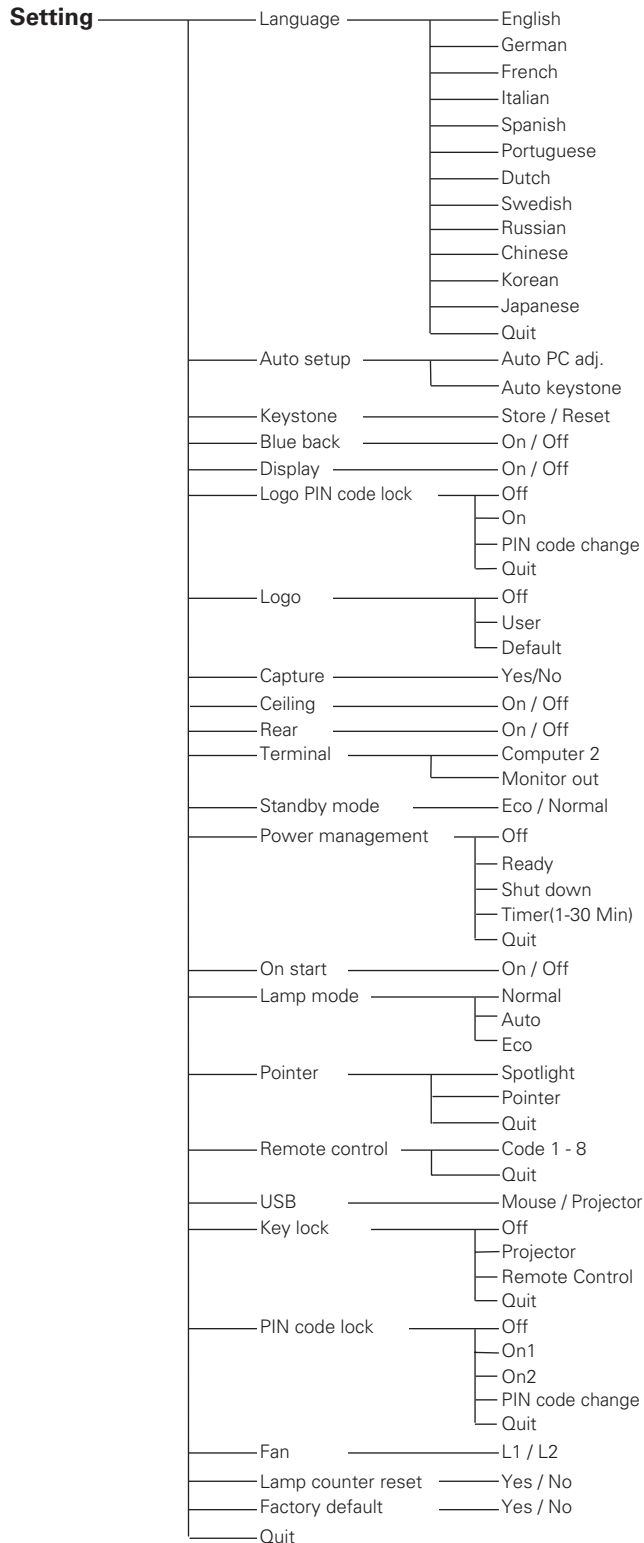

## Indicators and Projector Condition

Check the indicators for projector condition.

Indicators			Projector Condition
POWER red/green	WARNING red	LAMP REPLACE yellow	
●	●	●	The projector is OFF. (The AC power cord is unplugged.)
⦿	●	*	The projector is preparing for stand-by or the projection lamp is being cooled down. The projector cannot be turned on until cooling is completed.
⦿	●	*	The projector is ready to be turned on with the POWER ON-OFF button.
○	●	*	The projector is operating normally.
⦿	●	*	The projector is in the Power management mode.
⦿	⦿	*	The temperature inside the projector is abnormally high. The projector cannot be turned on. When the projector is cooled down enough and the temperature returns to normal, the POWER indicator lights red and the projector can be turned on. (The WARNING indicator keeps blinking.) Check and clean the Air filter.
⦿	⦿	*	The projector has been cooled down enough and the temperature returns to normal. When turning on the projector, the WARNING indicator stops blinking. Check and clean the air filters.
●	⦿	*	The projector detects an abnormal condition and cannot be turned on. Unplug the AC power cord and plug it again to turn on the projector. If the projector is turned off again, disconnect the AC power cord and contact the dealer or the service center for service and checkup. Do not leave the projector on. It may cause electric shock or a fire hazard.

○ ●●● lights green.

⦿ ●●● blinks green.

⦿ ●●● lights red.

⦿ ●●● blinks red.

● ●●● off

\* When the life of the projection lamp draws to an end, the LAMP REPLACE indicator lights yellow. When this indicator lights yellow, replace the projection lamp with a new one promptly. Reset the Lamp replace counter after replacement of the lamp. See page 52 and 53.

## Compatible Computer Specifications

LC-XB26/LC-XB21 can basically accept the signal from all computers with the V, H-Frequency mentioned below and less than 140 MHz of Dot Clock.

ON-SCREEN DISPLAY	RESOLUTION	H-Freq. (kHz)	V-Freq. (Hz)	ON-SCREEN DISPLAY	RESOLUTION	H-Freq. (kHz)	V-Freq. (Hz)
VGA 1	640 x 480	31.47	59.88	XGA 12	1024 x 768	35.522	86.96 (Interlace)
VGA 2	720 x 400	31.47	70.09	XGA 13	1024 x 768	46.90	58.20
VGA 3	640 x 400	31.47	70.09	XGA 14	1024 x 768	47.00	58.30
VGA 4	640 x 480	37.86	74.38	XGA 15	1024 x 768	58.03	72.00
VGA 5	640 x 480	37.86	72.81	MAC 19	1024 x 768	60.24	75.08
VGA 6	640 x 480	37.50	75.00	MAC 21	1152 x 870	68.68	75.06
VGA 7	640 x 480	43.269	85.00	SXGA 1	1152 x 864	64.20	70.40
MAC LC13	640 x 480	34.97	66.60	SXGA 2	1280 x 1024	62.50	58.60
MAC 13	640 x 480	35.00	66.67	SXGA 3	1280 x 1024	63.90	60.00
575i	————	15.625	50.00 (Interlace)	SXGA 4	1280 x 1024	63.34	59.98
480i	————	15.734	60.00 (Interlace)	SXGA 5	1280 x 1024	63.74	60.01
SVGA 1	800 x 600	35.156	56.25	SXGA 6	1280 x 1024	71.69	67.19
SVGA 2	800 x 600	37.88	60.32	SXGA 7	1280 x 1024	81.13	76.107
SVGA 3	800 x 600	46.875	75.00	SXGA 8	1280 x 1024	63.98	60.02
SVGA 4	800 x 600	53.674	85.06	SXGA 9	1280 x 1024	79.976	75.025
SVGA 5	800 x 600	48.08	72.19	SXGA 10	1280 x 960	60.00	60.00
SVGA 6	800 x 600	37.90	61.03	SXGA 11	1152 x 900	61.20	65.20
SVGA 7	800 x 600	34.50	55.38	SXGA 12	1152 x 900	71.40	75.60
SVGA 8	800 x 600	38.00	60.51	SXGA 13	1280 x 1024	50.00	86.00 (Interlace)
SVGA 9	800 x 600	38.60	60.31	SXGA 14	1280 x 1024	50.00	94.00 (Interlace)
SVGA 10	800 x 600	32.70	51.09	SXGA 15	1280 x 1024	63.37	60.01
SVGA 11	800 x 600	38.00	60.51	SXGA 16	1280 x 1024	76.97	72.00
MAC 16	832 x 624	49.72	74.55	SXGA 17	1152 x 900	61.85	66.00
XGA 1	1024 x 768	48.36	60.00	SXGA 18	1280 x 1024	46.43	86.70 (Interlace)
XGA 2	1024 x 768	68.677	84.997	SXGA 19	1280 x 1024	63.79	60.18
XGA 3	1024 x 768	60.023	75.03	SXGA 21	1400 x 1050	63.90	60.00
XGA 4	1024 x 768	56.476	70.07	MAC	1280 x 960	75.00	75.08
XGA 5	1024 x 768	60.31	74.92	MAC	1280 x 1024	80.00	75.08
XGA 6	1024 x 768	48.50	60.02	480p	————	31.47	59.88
XGA 7	1024 x 768	44.00	54.58	575p	————	31.25	50.00
XGA 8	1024 x 768	63.48	79.35	720p	————	45.00	60.00
XGA 9	1024 x 768	36.00	87.17 (Interlace)	1035i	————	33.75	60.00 (Interlace)
XGA 10	1024 x 768	62.04	77.07	1080i	————	33.75	60.00 (Interlace)
XGA 11	1024 x 768	61.00	75.70	1080i	————	28.125	50.00 (Interlace)

When an input signal is digital from DVI terminal, refer to the chart below.

ON-SCREEN DISPLAY	RESOLUTION	H-Freq. (kHz)	V-Freq. (Hz)	ON-SCREEN DISPLAY	RESOLUTION	H-Freq. (kHz)	V-Freq. (Hz)
D-VGA	640 x 480	31.47	59.94	D-SXGA 2	1280 x 1024	60.276	58.069
D-480p	————	31.47	59.94	D-SXGA 3	1280 x 1024	31.65	29.80
D-575p	————	31.25	50.00	D-720p	————	45.00	60.00
D-SVGA	800 x 600	37.879	60.32	D-1035i	————	33.75	60.00 (Interlace)
D-XGA	1024 x 768	43.363	60.00	D-1080i	————	33.75	60.00 (Interlace)
D-SXGA 1	1280 x 1024	63.98	60.02	D-1080i	————	28.125	50.00 (Interlace)

## Technical Specifications

### Mechanical Information

Projector Type	Multi-media Projector
Dimensions (W x H x D)	11.73" x 2.8" x 8.58" (298mm x 71mm x 218mm) (Not including adjustable feet)
Net Weight	6.2 lbs (2.8kgs)
Feet Adjustment	0° to 11.8°

### Panel Resolution

LCD Panel System	0.8" TFT Active Matrix type, 3 panels
Panel Resolution	1,024 x 768 dots
Number of Pixels	2,359,296 (1,024 x 768 x 3 panels)

### Signal Compatibility

Color System	PAL, SECAM, NTSC, NTSC4.43, PAL-M, PAL-N
High Definition TV Signal	480i, 480p, 575i, 575p, 720p, 1035i, and 1080i
Scanning Frequency	H-sync. 15 ~ 100 KHz, V-sync. 50 ~ 100 Hz

### Optical Information

Projection Image Size (Diagonal)	Adjustable from 40" to 300"
Projection Lens	F 1.7 ~ 2.5 lens with f 20.0 mm ~ 30.0 mm with manual zoom and focus
Throw Distance	3.3' ~ 25.3' (1.0m ~ 7.7m)
Projection Lamp	200W

### Interface

Video Input Jack	RCA Type x 1
S-Video Input Jack	Mini DIN 4 pin x 1
Audio Input Jacks	RCA Type x 2
Computer Input 1 Terminal	DVI-I Terminal (Digital / Analog) (HDCP Compatible)
Computer Input 2/ Component Input / Monitor Output Terminal	(VGA) HDB15 Terminal X 1 (In / Out switcheable)
Computer/ Component Audio Input Jacks	Mini Jack (stereo) x 1
Service Port Connector	Mini DIN 8 pin x 1
USB Connector	USB Series B receptacle x 1
Audio Output Jack	Mini Jack (stereo) x 1 (Variable)

### Audio

Internal Audio Amp	1.0W RMS
Built-in Speaker	1 speaker, ø1.1" (28mm)

### Power

Voltage and Power Consumption	AC 100 ~ 120 V (3.6 A Max. Ampere), 50 / 60 Hz (The U.S.A and Canada) AC 200 ~ 240 V (1.8 A Max. Ampere), 50 / 60 Hz (Continental Europe)
-------------------------------	--

### Operating Environment

Operating Temperature	41 °F ~ 95 °F (5 °C ~ 35 °C)
Storage Temperature	14 °F ~ 140 °F (-10°C ~ 60 °C)

### Remote Control

Battery	AA, UM3 or LR6 Type x 2
Operating Range	16.4' (5m) / ±30°
Dimensions	2.0" x 1.0" x 7.1" (50mm x 27mm x 181mm)
Net Weight	0.34 lbs (154 g) (including batteries)

## Accessories

---

Owner's Manual  
 AC Power Cord  
 Remote Control and Batteries  
 DVI-VGA Cable  
 USB Cable  
 Lens Cover with String and Screw  
 Soft Carrying Bag  
 PIN Code Label

- The specifications are subject to change without notice.
- LCD panels are manufactured to the highest possible standards. Even though 99.99% of the pixels are effective, a tiny fraction of the pixels (0.01% or less) may be ineffective by the characteristics of the LCD panels.
- The On-Screen Menu and figures in this manual may differ slightly from the product.

## Optional Parts

The parts listed below are optionally available. When ordering those parts, give the item name and Model No. to the sales dealer.

	<i>Model No.</i>
<b>DVI Cable</b>	: KA-DV20
<b>COMPONENT-VGA Cable</b>	: POA-CA-COMPVGA
<b>SCART-VGA Cable</b>	: POA-CA-SCART (This cable is used for RGB Scart 21-Pin Video output of video equipment.)
<b>Multi Card Director</b>	: MCD-100
<b>Compact Flash Card</b>	: CA-10
<b>Wired LAN Card</b>	: CA-20
<b>Wireless LAN Card</b>	: CA-30

When using the Wired or Wireless LAN Card, set the following name in the PJ Controller operation.

**Model Name: 08-4-1**

## Configurations of Terminals

### COMPUTER INPUT/COMPONENT INPUT/MONITOR OUTPUT TERMINAL (ANALOG)

Terminal : HDB15-PIN

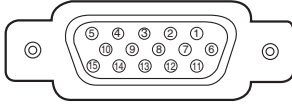

1	Red (R/Cr) Input / Output	9	----
2	Green (G/Y) Input / Output	10	Ground (Vert.sync.)
3	Blue (B/Cb) Input / Output	11	Ground / ----
4	----	12	----
5	Ground (Horiz.sync.)	13	Horiz. sync. Input/Output (Composite H/V sync.)
6	Ground (Red)	14	Vert. sync.
7	Ground (Green)	15	----
8	Ground (Blue)		

### DVI-I TERMINAL (DIGITAL/ANALOG)

Terminal : DVI-I

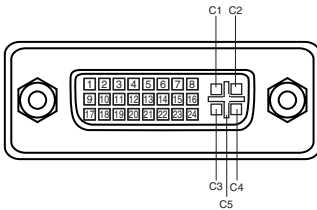

C1	Analog Red Input
C2	Analog Green Input
C3	Analog Blue Input
C4	Analog Horiz. sync
C5	Analog Ground (R/G/B)

1	T.M.D.S. Data2-	9	T.M.D.S. Data1-	17	T.M.D.S. Data0-
2	T.M.D.S. Data2+	10	T.M.D.S. Data1+	18	T.M.D.S. Data0+
3	T.M.D.S. Data2 Shield	11	T.M.D.S. Data1 Shield	19	T.M.D.S. Data0 Shield
4	No Connect	12	No Connect	20	No Connect
5	No Connect	13	No Connect	21	No Connect
6	DDC Clock	14	+5V Power	22	T.M.D.S. Clock Shield
7	DDC Data	15	Ground (for +5V)	23	T.M.D.S. Clock+
8	Analog Vert. sync	16	Hot Plug Detect	24	T.M.D.S. Clock-

### SERVICE PORT CONNECTOR

Terminal : Mini DIN 8-PIN

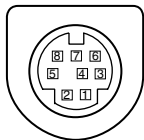

	Serial
1	R X D
2	----
3	----
4	GND
5	RTS / CTS
6	T X D
7	GND
8	GND

### USB CONNECTOR (Series B)

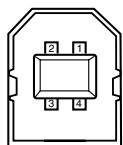

1	Vcc
2	- Data
3	+ Data
4	Ground

## PIN Code Number Memo

Write down the PIN code number in the column below and keep it with this manual securely. If you forgot or lost the number and unable to operate the projector, contact the service station.

**PIN Code Lock No.**

--	--	--	--

**Factory default set No: 1 2 3 4\***

**Logo PIN Code Lock No.**

--	--	--	--

**Factory default set No: 4 3 2 1\***

\*Should the four-digit number be changed, the factory set number will be invalid.

### While the projector is locked with the PIN code...

Put the label below (supplied) on in a prominent place of the projector's body while it is locked with a PIN code.

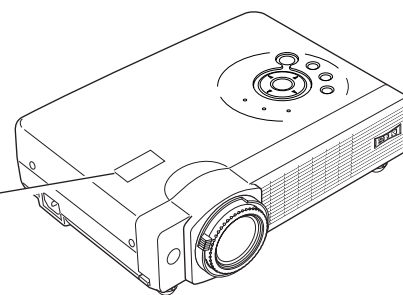

# EIKI

**A-key to better communications**

## **U.S.A.**

EIKI International, Inc.  
30251 Esperanza  
Rancho Santa Margarita  
CA 92688-2132  
U.S.A.  
Tel : 800-242-3454 (949)-457-0200  
Fax : 800-457-3454 (949)-457-7878  
E-Mail : usa@eiki.com

## **Deutschland & Österreich**

EIKI Deutschland GmbH  
Am Frauwald 12  
65510 Idstein  
Deutschland  
Tel : 06126-9371-0  
Fax : 06126-9371-14  
E-Mail : info@eiki.de

## **Canada**

EIKI CANADA - Eiki International, Inc.  
P.O. Box 156, 310 First St. - Unit 2,  
Midland, ON, L4R 4K8, Canada  
Tel : 800-563-3454 (705)-527-4084  
Fax : 800-567-4069 (705)-527-4087  
E-Mail : canada@eiki.com

## **Eastern Europe**

EIKI CZECH spol. s.r.o.  
Umělecká 15  
170 00 Praha 7  
Czech Republic  
Tel : +42 02 20570024  
+42 02 20571413  
Fax : +42 02 20571411  
E-Mail : easterneurope@eiki.de

## **Japan & Worldwide**

EIKI Industrial Company Limited.  
4-12 Banzai-Cho, Kita-Ku, Osaka,  
530-0028 Japan  
Tel : +81-6-6311-9479  
Fax : +81-6-6311-8486  
E-Mail : japan@eiki.com

**WorldWide Website <http://www.eiki.com>**